

COVER SHEET FOR PROPOSAL TO THE NATIONAL SCIENCE FOUNDATION

PROGRAM ANNOUNCEMENT/SOLICITATION NO./CLOSING DATE/if not in response to a program announcement/solicitation enter NSF 08-1					FOR NSF USE ONLY	
NSF 08-1					NSF PROPOSAL NUMBER	
FOR CONSIDERATION BY NSF ORGANIZATION UNIT(S) (Indicate the most specific unit known, i.e. program, division, etc.)						
DEB - Long-Term Ecological Research						
DATE RECEIVED	NUMBER OF COPIES	DIVISION ASSIGNED	FUND CODE	DUNS# (Data Universal Numbering System)	FILE LOCATION	
				929773554		
EMPLOYER IDENTIFICATION NUMBER (EIN) OR TAXPAYER IDENTIFICATION NUMBER (TIN)		SHOW PREVIOUS AWARD NO. IF THIS IS <input checked="" type="checkbox"/> A RENEWAL <input type="checkbox"/> AN ACCOMPLISHMENT-BASED RENEWAL		IS THIS PROPOSAL BEING SUBMITTED TO ANOTHER FEDERAL AGENCY? YES <input type="checkbox"/> NO <input checked="" type="checkbox"/> IF YES, LIST ACRONYM(S)		
480771751		0218210				
NAME OF ORGANIZATION TO WHICH AWARD SHOULD BE MADE			ADDRESS OF AWARDEE ORGANIZATION, INCLUDING 9 DIGIT ZIP CODE			
Kansas State University			Kansas State University			
AWARDEE ORGANIZATION CODE (IF KNOWN)			2 FAIRCHILD HALL			
0019281000			MANHATTAN, KS. 665061103			
NAME OF PERFORMING ORGANIZATION, IF DIFFERENT FROM ABOVE			ADDRESS OF PERFORMING ORGANIZATION, IF DIFFERENT, INCLUDING 9 DIGIT ZIP CODE			
PERFORMING ORGANIZATION CODE (IF KNOWN)						
IS AWARDEE ORGANIZATION (Check All That Apply) (See GPG II.C For Definitions)						
<input type="checkbox"/> SMALL BUSINESS <input type="checkbox"/> MINORITY BUSINESS <input type="checkbox"/> IF THIS IS A PRELIMINARY PROPOSAL THEN CHECK HERE <input type="checkbox"/> FOR-PROFIT ORGANIZATION <input type="checkbox"/> WOMAN-OWNED BUSINESS						
TITLE OF PROPOSED PROJECT Konza Prairie LTER VI: Grassland Dynamics and Long-Term Trajectories of Change						
REQUESTED AMOUNT		PROPOSED DURATION (1-60 MONTHS)		REQUESTED STARTING DATE		SHOW RELATED PRELIMINARY PROPOSAL NO. IF APPLICABLE
\$ 5,640,000		72 months		11/01/08		
CHECK APPROPRIATE BOX(ES) IF THIS PROPOSAL INCLUDES ANY OF THE ITEMS LISTED BELOW						
<input type="checkbox"/> BEGINNING INVESTIGATOR (GPG I.G.2) <input type="checkbox"/> HUMAN SUBJECTS (GPG II.D.6) Human Subjects Assurance Number _____ <input type="checkbox"/> DISCLOSURE OF LOBBYING ACTIVITIES (GPG II.C) Exemption Subsection _____ or IRB App. Date _____ <input type="checkbox"/> PROPRIETARY & PRIVILEGED INFORMATION (GPG I.D, II.C.1.d) <input type="checkbox"/> INTERNATIONAL COOPERATIVE ACTIVITIES: COUNTRY/COUNTRIES INVOLVED (GPG II.C.2.j) <input type="checkbox"/> HISTORIC PLACES (GPG II.C.2.j) <input type="checkbox"/> SMALL GRANT FOR EXPLOR. RESEARCH (SGER) (GPG II.D.1) <input type="checkbox"/> VERTEBRATE ANIMALS (GPG II.D.5) IACUC App. Date _____ <input type="checkbox"/> HIGH RESOLUTION GRAPHICS/OTHER GRAPHICS WHERE EXACT COLOR REPRESENTATION IS REQUIRED FOR PROPER INTERPRETATION (GPG I.G.1) PHS Animal Welfare Assurance Number _____						
PI/PD DEPARTMENT			PI/PD POSTAL ADDRESS			
Division of Biology			232 Ackert Hall			
PI/PD FAX NUMBER			Manhattan, KS 665064901			
785-532-6653			United States			
NAMES (TYPED)		High Degree	Yr of Degree	Telephone Number	Electronic Mail Address	
PI/PD NAME						
John M Blair		Ph.D.	1987	785-532-7065	jblair@ksu.edu	
CO-PI/PD						
Walter K Dodds		Ph.D.	1986	785-532-6998	wkdodds@ksu.edu	
CO-PI/PD						
David C Hartnett		PhD	1983	785-532-5925	dchart@ksu.edu	
CO-PI/PD						
Anthony Joern		PhD	1977	785-532-7073	ajoern@ksu.edu	
CO-PI/PD						
Jesse B Nippert		PhD	2006	785-532-0114	nippert@ksu.edu	

Konza Prairie LTER VI Investigators

<u>Principal Investigator</u>	<u>Department (KSU unless otherwise indicated)</u>	<u>Expertise</u>
John Blair, Ph.D.	Biology	Ecosystem/Soil Ecology
<u>Co-Principal Investigators</u>		
Walter Dodds, Ph.D.	Biology	Aquatic Ecosystem Ecology
Anthony Joern, Ph.D.	Biology	Community/Consumer Ecology
David Hartnett, Ph.D.	Biology	Plant Population Ecology
*Jesse Nippert, Ph.D.	Biology	Plant Ecophysiology
<u>Senior Personnel</u>		
*Sara Baer, Ph.D.	Plant Biol. (S. Illinois U)	Ecosystem/Soil/Restoration Ecology
John Briggs, Ph.D.	Biology	Plant/Landscape Ecology
Scott Collins, Ph.D.	Biology (U New Mexico)	Community Ecology
Keith Gido, Ph.D.	Biology	Aquatic/Consumer Ecology
Doug Goodin, Ph.D.	Geography	Climatology, Remote Sensing
Jay Ham, Ph.D.	Agronomy	Micrometeorology, C Flux
*John Harrington, Ph.D.	Geography	Climate, Human-Natural Systems
Loretta Johnson, Ph.D.	Biology	Plant Ecology, Ecological Genomics
Ari Jumpponen, Ph.D.	Biology	Microbial Ecology
Donald Kaufman, Ph.D.	Biology	Mammalian Ecology
Alan Knapp, Ph.D.	Biology (Colorado State U)	Grassland/Plant Ecology
Gwen Macpherson, Ph.D.	Geology (U Kansas)	Geochemistry
Charles Rice, Ph.D.	Agronomy	Soil Microbial Ecology
Brett Sandercock, Ph.D.	Biology	Avian Ecology, Population Biology
*Melinda Smith, Ph.D.	Ecol. Evol. Biol. (Yale)	Plant/Community/Ecosystem Ecology
Matt Whiles, Ph.D.	Zoology (S. Illinois U)	Aquatic Ecology, Insect Ecology
*Gail Wilson, Ph.D.	Nat. Res. Ecol. (OK State U)	Soil/Mycorrhizal Ecology
<u>LTER Staff Scientists</u>		
*Jincheng Gao, Ph.D.	Biology	Info Management, Remote Sensing
Glennis Kaufman, Ph.D.	Biology	Mammalian Ecology
E. Gene Towne, Ph.D.	Biology	Rangeland Ecology
Valerie Wright, Ph.D.	KPBS/Biology	Environmental Education
<u>Collaborating Scientists</u>		
*Joe Craine, Ph.D.	Biology	Plant/Ecosystem Ecology
Philip Fay, Ph.D.	USDA	Plant Ecology, Climate Change
Carolyn Ferguson, Ph.D.	Biology	Plant Systematics
Karen Garrett, Ph.D.	Plant Pathology	Plant Disease Ecology
Eva Horne, Ph.D.	Biology	Vertebrate Ecology
*Stacy Hutchinson, Ph.D.	Bio & Ag. Engineering	Hydrology
James Koelliker, Ph.D.	Civil Engineering	Hydrology
Robert McKane, Ph.D.	EPA (Corvallis, OR)	Ecological Modeling
*Kendra McLauchlan, Ph.D.	Geography	Biogeography, Paleoecology
*Kevin Price, Ph.D.	Geography/Agronomy	Remote Sensing/Landscape Ecology
Timothy Todd, M.S.	Plant Pathology	Nematology, Soil Ecology
*Samantha Wisely, Ph.D.	Biology	Conservation/Wildlife Biology
Gregory Zolnerowich, Ph.D.	Entomology	Insect Systematics

*new investigators added since LTER V

PROJECT SUMMARY

We request funding to continue and expand the Konza Prairie Long-Term Ecological Research program. The Konza Prairie LTER Program (KNZ) is a comprehensive, interdisciplinary research program designed to provide a mechanistic and predictive understanding of ecological processes in mesic grasslands, and contribute to synthesis and broad conceptual advances in ecology. KNZ also offers education and training at all levels (K-12 to postgraduate), as well as public outreach, and contributes ecological knowledge essential for addressing land-use and management issues in grasslands. Since its inception, long-term studies and experiments at Konza Prairie have been linked by an overarching theme that integrates **fire, grazing and climatic variability as essential and interactive factors responsible for the origin, evolution, persistence and functioning of tallgrass prairie, with relevance to grasslands globally**. The interplay of these drivers across a heterogeneous landscape leads to high species diversity (*e.g.*, > 600 plant species) and complex ecological dynamics, making KNZ data relevant for addressing many basic ecological issues (*e.g.*, productivity-diversity relationships, disturbance and community stability, top-down vs. bottom-up controls, the interplay of mutualistic and antagonistic biotic interactions, and biotic responses to present and future environmental variability). Because human activities are directly (by managing grazers and fire) and indirectly (by changing atmospheric chemistry and climate) altering the key drivers of ecological processes in grasslands worldwide, KNZ research is increasingly used to address critical global change issues, including the impacts of land-use and land-cover change, altered biogeochemical and hydrologic cycles, and climate change.

Our broad goals for LTER VI are to: **(1) maintain and expand the strong core LTER experiments and long-term datasets on fire, grazing and climatic variability begun over 25 years ago, with the goal of refining our understanding of the major abiotic and biotic factors determining grassland structure and function; (2) continue developing a mechanistic and predictive understanding of grassland dynamics and trajectories of change in response to global change drivers, using ongoing and new long-term experiments and datasets coupled with shorter-term supporting studies; (3) support and promote new synthesis activities based on our LTER results and data from other sites and studies, use these syntheses to expand the inference of KNZ results, and to develop and test ecological theory; and (4) continue education and outreach activities to promote the relevance of our research to society.**

To accomplish these goals, core Konza LTER experiments and datasets will be extended, while new experiments, datasets, and cross-site studies are initiated. During LTER VI, we will: (1) continue core long-term experiments focused on responses to land-use (especially fire and grazing) and climatic variability, with the addition of new treatments and response variables; (2) expand studies of woody plant encroachment into grasslands, a critical land-cover change, to include new consumer and ecosystem responses and add new paleoecological perspectives; (3) assess rates and trajectories of change during restoration of grasslands; (4) expand climate change studies; (5) continue and expand long-term studies of nutrient enrichment and interactions with land-use practices, with new emphasis on linking above- and belowground responses; (6) initiate new studies on the consequences of altered nutrient regimes for streams, and on linkages between terrestrial land-cover change and streams; and (7) use KNZ data to support regional ecological studies and place our research in the context of regional socio-ecological systems. New KNZ LTER studies will examine the mechanisms driving trajectories and rates of biotic responses to environmental change, including human responses to these changes (*e.g.*, conservation and restoration). Finally, we will continue to use KNZ LTER data to promote formal integration and synthesis, at the site-level and beyond, to advance ecological understanding of this and other ecosystems.

The intellectual merit of this research will be an increased understanding of the key ecological processes underlying pattern and process in grassland ecosystems, and a predictive understanding of the responses of grasslands to global change. Our research will also contribute to the advancement of ecology through synthesis and integration of data from a series of unique long-term studies. **The broader impacts** of the research include providing educational opportunities for K-12 students, training a future generation of ecologists, contributing to public education, and developing and disseminating a knowledge base essential for the ecologically sound management of grassland ecosystems worldwide.

TABLE OF CONTENTS

For font size and page formatting specifications, see GPG section II.C.

	Total No. of Pages	Page No.* (Optional)*
Cover Sheet for Proposal to the National Science Foundation		
Project Summary (not to exceed 1 page)	1	_____
Table of Contents	1	_____
Project Description (Including Results from Prior NSF Support) (not to exceed 15 pages) (Exceed only if allowed by a specific program announcement/solicitation or if approved in advance by the appropriate NSF Assistant Director or designee)	49	_____
References Cited	24	_____
Biographical Sketches (Not to exceed 2 pages each)	53	_____
Budget (Plus up to 3 pages of budget justification)	18	_____
Current and Pending Support	27	_____
Facilities, Equipment and Other Resources	3	_____
Special Information/Supplementary Documentation	28	_____
Appendix (List below.) (Include only if allowed by a specific program announcement/ solicitation or if approved in advance by the appropriate NSF Assistant Director or designee)	_____	_____
Appendix Items:		

*Proposers may select any numbering mechanism for the proposal. The entire proposal however, must be paginated. Complete both columns only if the proposal is numbered consecutively.

I. RESULTS OF PRIOR SUPPORT. Blair, Briggs, Hartnett, Johnson, Knapp and others. 2002-2008. *Konza Prairie LTER V: Long-Term Research on Grassland Dynamics and Global Change*. \$4,680,000.

The Konza Prairie LTER Program (KNZ) is a comprehensive, interdisciplinary research program designed to provide a mechanistic and predictive understanding of ecological processes in mesic grasslands, and contribute to synthesis and conceptual advances in ecology. Konza LTER also offers education and training at all levels (K-12 to postgraduate), as well as public outreach, and contributes ecological knowledge essential for addressing land-use and management issues in grasslands. Our focal research site is the Konza Prairie Biological Station, 3487 ha of native tallgrass prairie in the Flint Hills of Kansas. With LTER funding, we have amassed long-term datasets (many that span >25 yrs) on key ecological processes such as hydrology, nutrient cycling, productivity, and community and population dynamics of plants and consumers. These long-term records provide unique insights into the dynamics and functioning of tallgrass prairie ecosystems, while serving as a critical baseline for identifying and interpreting ecological responses to environmental change. The KNZ program encompasses diverse studies that span multiple ecological levels and a range of spatial and temporal scales. **The unifying conceptual framework guiding this body of research is that three key drivers – fire, grazing and climatic variability – are essential and interactive factors shaping the origin, evolution, persistence and functioning of tallgrass prairie, with relevance to grasslands globally.** The interplay of these drivers across a heterogeneous landscape leads to high species diversity and complex ecological dynamics, making KNZ data relevant for addressing many basic ecological issues (*e.g.*, productivity-diversity relationships, disturbance and community stability, top-down vs. bottom-up controls, the interplay of mutualistic and antagonistic biotic interactions, and biotic responses to present and future environmental variability). Because human activities directly (managing grazers and fire) and indirectly (changing atmospheric chemistry and climate) alter the key drivers of ecological processes in grasslands worldwide, KNZ research is increasingly used to address critical global change issues, including the ecology of invasions, land-use and land-cover change, altered water quality, and climate change.

From January 2002 to January 2008, the KNZ program produced or contributed to **322 publications** (Fig. 1 and *Supplemental Documentation*), including **250 refereed journal articles, 2 books, 10 book chapters, 49 dissertations and theses, and 11 other publications**. The number of Konza publications in high impact journals increased (Fig. 2), as did the mean number of authors per publication, reflecting extensive collaboration within and among research groups. The KNZ philosophy is to support core long-term research and provide a research platform from which we can leverage additional extramural funding to strengthen our research base and support complementary studies connected to our long-term goals. During LTER V, over \$16M in new awards in addition to LTER funding were secured in support of ecological research at Konza (*Supplemental Documentation*). Finally, we maintained involvement of long-time investigators (at KSU and other institutions) and attracted new investigators, resulting in continued growth and diversification of our LTER program (see LTER Personnel and CVs).

Below we highlight results from selected KNZ research areas, illustrating the breadth and significance of ecological studies comprising our program. These results relate to our overall goal of understanding how fire, grazing and climatic variability interact to shape the structure and function of mesic grasslands, and demonstrate how KNZ research has contributed to general ecological knowledge and theory.

Ecological Effects of Fire. Fire is integral to the ecology of mesic grasslands worldwide, and the effects of fire on ecosystem processes as well as plant and consumer populations and communities is a major focus of the KNZ program. We maintained watershed-level treatments to assess the long-term (>30 yrs) effects of different spring fire frequencies (1-, 2-, 4-, 10- and 20-yr intervals). Different fire regimes significantly alter aboveground net primary productivity (ANPP; Fig. 3) and plant community composition (Fig. 4) and trajectories of change (Collins 2000), as well as species composition of consumers, including grasshoppers and herpetofauna (Joern 2005, Wilgers & Horne 2006, Jonas & Joern 2007). More recently we initiated experiments on seasonal timing of fires. Eight yrs of annual burning in spring, autumn and winter all promoted increases in cover of warm-season (C₄) grasses (Towne & Kemp 2003). However, cover of the dominant grass *Andropogon gerardii* increased with all burn regimes,

whereas *Sorghastrum nutans* increased only with spring burning. Because these two co-dominant species contribute disproportionately to primary productivity (Smith & Knapp 2003) and vary in their response to environmental drivers (Silletti & Knapp 2002, Swemmer *et al.* 2006), frequency and timing of fire may interact with climate change to alter community dynamics and productivity under future climates (Fay *et al.* 2003). We also began new experiments to assess the legacy effects of fire history on trajectories of response to altered fire frequency. Long-term fire treatments were ‘reversed’ on two watersheds previously burned annually in spring and two watersheds protected from fire for ~20 yrs (the ‘Fire Reversal Experiment’). Although floristic richness or diversity changed little within 5 yrs, significant non-symmetrical changes in cover occurred among the major plant functional groups. For example, when subjected to annual burning after long-term fire suppression, C₄ grass cover increased by 48% and cover of C₃ graminoids declined by 64%. In contrast, C₄ grass cover declined by only 13%, C₃ graminoid cover did not change, and perennial forb cover increased within 5 yrs of fire suppression. Cover of woody vegetation (Fig. 5) and soil N availability decreased with repeated fires, and increased with fire exclusion. These results confirm rapid changes in soil properties and plant communities with initiation of frequent fire after long-term fire exclusion, with important implications for grassland management and restoration

Konza LTER V studies also addressed the effects of fire on nutrient cycling, particularly soil N dynamics. Although fire volatilizes N and reduces N availability, frequently burned grasslands retain more N than those burned less frequently. The fate of a pulse of ¹⁵NH₄⁺ added to soil was tracked over 5 growing seasons to assess how annual fire affects N cycling and partitioning among soil and plant pools. Initial immobilization of the added N in soil and microbial pools was rapid (Dell & Rice 2005), and recovered ¹⁵N moved from soil to roots and then rhizomes during the first growing season. After one growing season, burned plots retained significantly more added ¹⁵N (85%) than unburned plots (55%), consistent with greater N limitation under high fire frequencies. Plants gradually lost ¹⁵N over the next 4 yrs, and most ¹⁵N was recovered in soil pools, with consistently higher total N retention in burned plots (Fig. 6; Dell *et al.* 2005).

The Role of Grazers in Mesic Grasslands. LTER V studies addressed the mechanisms by which grazers influence plant communities, as well as grazer responses to heterogeneous vegetation. Bakker *et al.* (2003) linked increased plant species richness in the presence of bison with greater heterogeneity of plant cover and light (Fig. 7). Relationships between plant species turnover (LTER data) and richness also suggested that bison influence local extinction and colonization. A 10-yr comparative study of native (bison) and domestic (cattle) grazers revealed that both bison and cattle increased cover of subdominant species, including annual forbs, perennial forbs, and cool-season graminoids, but forb cover and total species richness increased at a greater rate with bison than with cattle (Towne *et al.* 2005). Plant communities grazed by bison and cattle were 85% similar after 10 yr, and differences between bison- and cattle-grazed prairie were less than differences between grazed and ungrazed prairie. Impacts of ungulate grazers, especially on vegetation structure and habitat availability, greatly influence many other terrestrial consumers, resulting in increased animal species richness and abundance in response to increased spatial heterogeneity (*e.g.*, Joern 2004, 2005, Jonas & Joern 2007).

Fire and Grazing Interactions. LTER V studies assessed the interactive effects of fire frequency and bison grazing on grassland plants and consumers across scales. Grazer-induced changes in vegetation structure and plant community composition can affect consumer responses to the combined effects of fire and grazing (Mong 2005, Powell 2006, Wilgers *et al.* 2006, Jonas & Joern 2007). Collins & Smith (2006) examined spatial and temporal heterogeneity in plant community composition (but not structure) at 10-, 50-, and 200-m² scales in response to combinations of fire and grazing over 9-yrs. Spatial and temporal heterogeneity in plant community composition was lowest in annually burned sites and highest in infrequently burned sites, while grazing reduced spatial heterogeneity and increased temporal heterogeneity at all scales examined. Thus, the independent effects of fire and grazing were not scale-dependent; however, their interactions differed with scale, reflecting differences in frequency, intensity and spatial extent of grazing by bison as a function of fire frequency. In a separate study, Veen *et al.* (*in press*) found that grazing enhanced light and N availability, but did not affect small-scale (< 10 m) resource variability. Grazing also reduced C₄ grass dominance, which enhanced species richness,

diversity, and community heterogeneity at scale < 10 m. In contrast, annual fire increased C₄ grass dominance and reduced species richness and diversity, but had no effect on community heterogeneity, or resource availability and variability at these scales. Thus, bison appear to generate small-scale community heterogeneity directly by altering plant community dominance, rather than indirectly by changing resource variability.

Plant Population Ecology. We expanded our mechanistic understanding of vegetation composition and dynamics by focusing on belowground processes regulating plant responses to key ecological drivers. Most plant recruitment in tallgrass prairie is from belowground meristems (buds and rhizomes) rather than seed rain or seed banks (Benson *et al.* 2004, Benson & Hartnett 2006). Matrix models and sensitivity analyses of the two co-dominant grasses showed that life history processes associated with vegetative reproduction and belowground meristems drive grass population dynamics and responses to fire and grazing (Benson & Hartnett 2006, Dalgleish 2007). For example, aboveground growth, biomass and seed production all decreased markedly with increasing defoliation intensity, while belowground bud production remained unaffected, indicating that maintenance of dormant meristems belowground can contribute to the resilience and recovery of grass populations following herbivory. Comparable studies in southern African grasslands are testing the generality of our findings (Hartnett *et al.* 2004, 2006). A large bud bank may also decrease the invasibility of tallgrass prairie plant communities by exotic species; there is a threshold bud bank density below which the frequency of exotic species increases markedly. Maintaining a reserve bud bank probably increases the relative ability of resident species to capitalize on resource pulses and constrains the opportunity for invasion. Other Konza studies on exotic plant populations showed that fitness homeostasis through a balanced and plastic allocation to seed vs. vegetative reproduction accounts for successful invasion (*e.g.*, Woods *et al. in review*). Collectively, these studies are leading to a proposed modification of the Davis *et al.* (2000) theory of invasibility.

Interplay of Mutualistic Interactions. Konza research established that mycorrhizal symbioses are ubiquitous in grasslands and strong determinants of plant growth, reproduction, competitive relationships, and patterns of species diversity (Hartnett & Wilson 2002). Mycorrhizal plants acquire more P, which can be redistributed among individuals with and between species via an underground network of hyphal connections (Wilson *et al.* 2006). Mycorrhizas also strongly influence compensatory growth and tolerance to herbivory (Kula *et al.* 2005) which, in turn, influences mycorrhizal colonization rates (Villareal *et al.* 2006). These studies provide important new insights into the role of belowground biotic interactions in explaining and predicting grassland vegetation responses to environmental changes.

Diversity, Productivity and Invasibility. We increased our understanding of how plant diversity impacts ecosystem functioning (productivity) and invasion by manipulating plant diversity and abundance of dominant C₄ grasses (Smith & Knapp 2003, Smith *et al.* 2004). A 4-fold loss in plant diversity, based on patterns of rare species loss first, had little impact on aboveground productivity or patterns of invasion. In contrast, reduced abundance (25% or 50% reduction) of the dominant C₄ grasses had immediate and significant impacts on productivity and establishment of invaders. These results underscore the importance of dominant species in maintaining ecosystem functioning under natural patterns of species loss and determining susceptibility of communities to invasion. We also continued to assess the consequences of species invasions for ecosystem processes (Reed *et al.* 2005b, Baker 2007).

Woody Vegetation Expansion into Grasslands. Increased woody plant cover in grasslands is a global phenomenon and a critical threat to conservation of grasslands and their biodiversity (Hoch *et al.* 2002, Knapp *et al.* 2008, Matlack *et al. in press*). Changes in land management, such as reduced fire frequency, can increase woody plant abundance, while other factors such as increased CO₂ concentration, N deposition, and habitat fragmentation might be contributing factors. Briggs *et al.* (2005) synthesized >20 yrs of data from Konza and surrounding areas to elucidate the causes and consequences of the transition of C₄-dominated grasslands to shrublands and woodlands. The transition from grassland to shrubland is contingent upon fire-free intervals, which facilitate recruitment of new individuals and additional woody plant species (Fig.8). Once established, shrub cover can increase even with periodic fires, and infrequent fires can accelerate the spread of some shrub species (Heisler *et al.* 2003, 2004), contributing to a new

dynamic state of shrub-grass co-existence in mesic grasslands. In tallgrass prairie, increases in woody species can increase productivity and ecosystem C storage at the expense of species diversity (Lett *et al.* 2004). While woody vegetation provides critical habitat for songbirds of conservation concern (Kosciuch *et al.* 2006), it can also negatively impact grassland bird communities because parasitic cowbirds have high productivity in nests of shrub-nesting songbird hosts (Kosciuch *et al. in press*, Kosciuch & Sandercock *in press*). We also documented changes in C and N cycling (reduced soil respiration, increased ecosystem N use efficiency, increased storage of C and N) resulting from complete conversion of grassland to *Juniperus virginiana* woodland using paired forest-grassland sites in the region (Smith & Johnson 2003, 2004, Norris *et al.* 2007, McKinley *et al.* 2008). Finally, Knapp *et al.* (2008) synthesized woody plant encroachment studies from multiple biomes, and found that relatively abrupt (< 50 yrs) shifts in growth form dominance fundamentally alters C inputs and responses to precipitation.

Responses to Climatic Variability and Climate Change. Variable and complex responses of grasslands to climatic variability present a significant challenge for forecasting responses to future climate change (Nippert *et al.* 2006). During LTER V, we continued to assess responses to climatic variability and potential future climate change. Since 1998, we have manipulated rainfall amounts and timing (variability) to native prairie plots using Rainfall Manipulation Plots (RaMPs) (modified rainout shelters; Fay *et al.* 2000, 2003). Altered timing of rainfall events, with no change in total rainfall amount, has significant consequences from the physiology of individual plants to ecosystem C fluxes (Fig. 9; Knapp *et al.* 2002, Fay *et al.* 2003, Harper *et al.* 2005). RaMPs data were also used for soil hydrology modeling studies (Daly & Porporato 2006, Porporato *et al.* 2006), and to illustrate the use of genomic tools in field studies of species responses to environmental change (Travers *et al.* 2007). LTER V also included new experiments to assess stream responses to increased hydrologic variability (flood and drought) related to climate change. We developed an experimental stream facility to run replicated experiments at realistic spatial and temporal scales (Matthews *et al.* 2006), and supported new research on predator-prey relations (Knight & Gido 2005) and responses of stream communities and ecosystems to varying frequency and/or intensity of floods and drought (Fig. 10; Bertrand & Gido 2007, Murdock & Dodds 2007).

While future climate changes will undoubtedly affect grasslands, current environmental variability drives contemporary landscape patterns in species occurrence and abundance. Nippert & Knapp (2007a, b) measured differences in water availability, plant water stress, and source of water used by C₄ grasses and C₃ forbs and shrubs to demonstrate that co-occurring species differ in patterns of water-use, and some species alter water-use based on climate and site-specific environmental variability. Across a regional gradient from tallgrass prairie to desert grasslands, Dalglish & Hartnett (2006) found a strong positive correlation between bud bank densities and interannual variation in annual net primary productivity (ANPP). Lower variability in ANPP in more arid grasslands can result from meristem limitation, constraining the capacity of these grasslands to respond to current or future climate variability (Dalglish & Hartnett 2006). Climate change signals and responses to changing habitats also affect the dynamics of grassland consumers (Rehmeier *et al.* 2005, Sandercock 2006, Reed *et al.* 2007, Jonas & Joern 2007, Sandercock *et al. in press*), underscoring the need for an integrative approach to climate change studies.

Ecology and Biogeochemistry of Streams and Groundwater. Grassland stream and groundwater studies are an important aspect of the KNZ program. We monitored discharge and nutrient chemistry from 4 watersheds of different fire frequencies in the Kings Creek drainage network, resulting in several publications on N cycling (Kemp & Dodds 2001, Dodds *et al.* 2002, Dodds & Oakes 2006, O'Brien & Dodds *in press*). We established that N processing efficiency decreases as N loading increases (O'Brien *et al.* 2007), and provided the first description of organic C transport from grasslands (Eichmiller 2007) while verifying that substrate heterogeneity alters O₂ dynamics (Wilson 2005). Konza LTER data provided a baseline for characterizing native prairie streams (Whiles & Dodds 2002, Dodds *et al.* 2004). For example, a method for estimating reference nutrient concentrations across ecoregions was validated using actual reference conditions in Kings Creek (Dodds & Oakes 2004). Konza LTER stream research provided context for grassland stream N studies in the LINX II initiative (O'Brien *et al.* 2007) and general patterns found for Flint Hills streams applied to streams across North America (Mulholland *et al. in press*). Geochemical monitoring at Konza revealed that soil nitrate is removed during rapid recharge

events (3-5 months) as water moves from limestone aquifers into alluvial aquifers (Macpherson & Sophocleous 2004), and showed that atmospheric dust, not weathering of limestone, is the likely main source of Sr and Ca in limestone aquifers (Wood & Macpherson 2005). We also found that groundwater CO₂ concentrations are increasing (Macpherson *et al.* 2006 and *in review*).

We synthesized two decades of KNZ stream research and developed a conceptual model (Fig. 11, Dodds *et al.* 2004) that highlights the unique nature of prairie stream communities and ecosystems, and linkages with terrestrial ecosystems (Stagliano & Whiles 2002, Franssen *et al.* 2006). We are now completing a comprehensive assessment of longitudinal patterns of primary and secondary productivity and community structure, which will refine this conceptual model by quantifying reach-scale metabolism and food web structure along a gradient from open, grassy headwaters to lower forested reaches. This study also provides rationale for new riparian vegetation studies outlined in the Project Description.

Restoration Ecology. Restoration studies at Konza focused on applying ecological theory to better understand abiotic and biotic constraints (“filters”) to the re-assembly of diverse tallgrass prairie communities, with the goal of advancing the theory and practice of ecological restoration. Restoration experiments during LTER V demonstrated that soil N availability modulates the initial establishment of native and non-native species, rates of species loss, and change in community diversity over time (Fig. 12; Baer *et al.* 2003, 2004, 2005). We developed predictive relationships for trajectories and rates of increase in soil, microbial and root C and N pools over 12 yrs of grassland restoration (Baer *et al.* 2002). We also documented positive feedback between soil N supply and ANPP under nutrient enrichment that served to override progressive N limitation as C accrues in soils (Baer & Blair *in press*). Restoration studies and KNZ research were highlighted in a 2007 *Science News* (172:369-384) cover story.

Synthesis, Cross-Site and LTER Network-Level Activities. The KNZ LTER program includes (1) synthetic analyses of long-term site data, (2) leadership and data for broader network-level analyses, and (3) application of KNZ findings to other ecosystems. Thus, our synthetic activities provide new insights into grassland ecology, as well as the basic underpinnings of ecological patterns and processes across biomes. Several site-based syntheses were described above; others focused on the ecology of grassland arthropods (Whiles & Charlton 2006), insect herbivory in grasslands (Branson *et al.* 2006), estimation of demographic parameters for plant and animal populations (Sandercock 2006), and effects of climate change on plant diseases (Garrett *et al.* 2006). Konza LTER data were used to assess patterns of grassland species abundance (Harpole and Tilman 2006), diversity-invasion relationships in plant communities (Cleland *et al.* 2004), productivity-diversity relationships in plant and consumer communities (Reed *et al.* 2006a, Grace *et al.* 2007), and remotely sensed estimates of LAI and productivity across biomes (Cohen *et al.* 2003, 2006, Turner *et al.* 2003a, 2006). Other cross-site contributions include studies of: plant and microbial community responses to long-term N additions (Pennings *et al.* 2005, Suding *et al.* 2005, Clark *et al.* 2007, Edgerton-Warburton *et al.* 2007, Zeglin *et al.* 2007), mechanisms of community organization (Chalcraft *et al.* 2004, Adler *et al.* 2005, Schaefer *et al.* 2005, Dodds & Nelson 2006, White *et al.* 2006, Heatherly *et al.* 2007, Houlahan *et al.* 2007), effects of herbivore size across productivity gradients (Bakker *et al.* 2006), production-precipitation relationships in grasslands (Knapp *et al.* 2006, Dalglish & Hartnett 2006), plant root properties across biomes (Craine *et al.* 2005), and regional patterns of nutrient cycling (Barrett *et al.* 2002, McCulley *et al.* 2005). Konza scientists participated in the LINX I and II experiments (Dodds *et al.* 2002, 2004, Mulholland *et al.* *in press*), and other cross-site stream studies (Tank & Dodds 2003, Dodds & Whiles 2004). Konza LTER scientists have been leaders in coordinating LTER-network activities including a cross-site working group on shrub encroachment (Knapp *et al.* 2008), and the ANPP (Smith, Knapp) and Ecotrends Discovery (Joern) working groups. Konza scientists also participated in workshops and manuscripts for the LTER *BioScience* issue (Foster *et al.* 2003, Turner *et al.* 2003b), contributed to papers from the NCEAS PrecipNet and Trophic Structure working groups (Weltzin *et al.* 2003, Huxman *et al.* 2004), and provided editorial leadership for two new books in the Oxford LTER series (Greenland *et al.* 2003, Fahey & Knapp 2007). Finally, participation in international research expanded in LTER V. Hartnett co-led an NSF workshop to foster collaborative ecological research in sub-Saharan Africa (Hartnett & Semazzi 2006), and KNZ publications included international collaborators and data (*e.g.*, Hartnett *et al.* 2004, 2006, Knapp *et al.* 2004, 2006, Swemmer *et al.* 2007).

II. PROJECT DESCRIPTION

A. Introduction and Background. The Konza LTER program (KNZ) is an interdisciplinary research program, which emphasizes (1) understanding ecological processes in mesic grasslands and (2) advancing general ecological knowledge. KNZ also offers education and training at all levels, contributes knowledge to address land-use and management decisions, and provides infrastructure and data to support activities in a broad range of disciplines. KNZ research encompasses studies across multiple ecological levels (genomic to ecosystem) and spatial and temporal scales. Our research program has evolved over time, but it has been guided since its inception by a **unifying conceptual framework that explicitly considers three key drivers – fire, grazing and climatic variability – are essential and interactive factors shaping the origin, evolution, persistence and functioning of tallgrass prairie, with relevance to grasslands globally** (Fig. 13). The interplay of these drivers and biotic responses across a heterogeneous landscape leads to high species diversity and complex biotic and ecosystem dynamics characteristic of grasslands (Knapp *et al.* 1998, Dodds *et al.* 2004, Joern 2005). Because human activities are directly (management of grazing and fire) and indirectly (changes in atmospheric chemistry, nutrient inputs and climate) altering these key drivers in grasslands worldwide, KNZ data are relevant for addressing critical responses to these and other anthropogenic changes, including: spread of invasive species (Cleland *et al.* 2004, Smith *et al.* 2004, Reed *et al.* 2005b); land-use and land-cover change (Heisler *et al.* 2003, Lett *et al.* 2004, Briggs *et al.* 2005, Norris *et al.* 2007); altered biogeochemistry (Dodds *et al.* 2004, Bernot & Dodds 2005, Dodds 2006, Clark *et al.* 2007); and climate change (Knapp *et al.* 2002, Fay *et al.* 2003, Harper *et al.* 2005). Knowledge from KNZ studies has value beyond the borders of the site, providing important insights for forecasting the future of grasslands and other ecosystems globally. Konza LTER data are also sufficiently comprehensive to address a range of fundamental ecological issues such as patterns and controls of community organization (Chalcraft *et al.* 2004, Adler *et al.* 2005, White *et al.* 2006), maintenance of biodiversity (Collins *et al.* 2002, Hickman *et al.* 2004), ‘top down’ vs. ‘bottom up’ controls of ecological processes (Bakker *et al.* 2003, 2006, Bertrand & Gido 2007), the interplay of mutualistic and antagonistic interactions (Hartnett & Wilson 2002, Kula *et al.* 2005), and application of ecological theory to restoration and management (Baer *et al.* 2003, 2005, Branson *et al.* 2006).

History and Growth of the Konza Prairie LTER Program. The KNZ LTER program was among the first funded by NSF in 1981, but some datasets extend back >30 yrs. We have built on long-term studies and datasets in each of the 5 original LTER “core areas” (Callahan 1984), and the value of these datasets increases with the length of record. A long-term perspective has proven to be essential for understanding the causes and consequences of human-driven changes (Briggs *et al.* 2005), particularly in grasslands, which are characterized by high interannual variation in abiotic drivers and ecological responses (Kemp & Dodds 2001, Knapp & Smith 2001, Rehmeier *et al.* 2005, Nippert *et al.* 2006, Jonas & Joern 2007).

LTER I (1981-1986) focused on biotic responses to fire and climatic variability. Watershed-level fire treatments, long-term research sites and sampling protocols were established with emphasis on the extremes of fire frequency and topography. During **LTER II** (1986-1990), Konza research expanded to encompass a range of fire frequencies and additional ecosystem responses, as well as important belowground processes. Research at broader spatial scales used remotely-sensed data in conjunction with the collaborative NASA FIFE program. **LTER III** (1991-1996) established bison and cattle grazing treatments to address effects of grazers on processes and patterns imposed by fire frequency over the landscape mosaic, all under a variable climate. During **LTER IV** (1996-2002), we focused on fire-grazer interactions, effects of history and season of fires, net ecosystem carbon exchange, restoration ecology and land-use/land-cover change (LULCC). In total, research during LTER I-IV encompassed the major abiotic (climate, fire, topoedaphic gradients, hydrology) and biotic (herbivory, competition, mycorrhizal symbiosis) factors affecting mesic grasslands, and solidified a non-equilibrium perspective on ecological patterns and processes (Knapp *et al.* 1998). With **LTER V** (2002-2008) we focused research on the role of humans as an increasingly dominant driver of ecological change. Humans are altering ecological processes in grasslands and other ecosystems, often in ways without recent historical analogs (Overpeck *et al.* 2003, Williams *et al.* 2007), thus emphasis was placed on grassland responses to altered climate, land-use, hydrologic and biogeochemical cycles, and species introductions and losses. Konza **LTER VI**

(2008-2014) will continue to address fundamental ecological questions, but with an emphasis on understanding the consequences of global change for ecological dynamics in grasslands (Fig. 14), a theme relevant to understanding, managing and conserving grasslands worldwide. We define global change as human-induced alterations in land-use, climate, hydrologic and biogeochemical cycles, and biodiversity dynamics. Of these, LULCC may be the most substantial human alteration of the Earth's ecosystems, and one that interacts strongly with all other facets of global change (Vitousek *et al.* 1997). We will focus on long-term responses to facets of global change most relevant to grasslands and grassland streams – *changes in land-use* (fire and grazing regimes, grassland restoration) and *land-cover* (particularly increases in woody plant cover); *climate change and altered hydrology*; and *altered nutrient cycles* (enhanced N deposition) – and we will couple long-term observations with manipulative studies to provide mechanistic explanations for these responses. Our research will also address biotic interactions (competition, mutualism, predation, herbivory) in grasslands, and will continue to provide insight into a broad range of general ecological phenomena. In total, our goals for KNZ VI are to:

1. **maintain and expand the strong core LTER experiments and data sets on fire, grazing and climatic variability begun over 25 years ago, with the goal of refining our understanding of the major abiotic and biotic factors determining grassland structure and function;**
2. **continue developing a mechanistic and predictive understanding of grassland dynamics and trajectories of change in response to global change drivers, using ongoing and new long-term experiments and datasets coupled with shorter-term supporting studies;**
3. **support and promote new synthesis activities based on our LTER results and data from other sites and studies, to use these syntheses to expand the inference of KNZ results, and to develop and test ecological theory;**
4. **continue education and outreach activities to make our results relevant to society.**

Ongoing Konza LTER experiments and datasets will be extended, while new experiments, datasets, and cross-site studies are initiated. **These long-term studies are essential for documenting responses to global change, and some of our most significant findings have emerged after 10 yrs or more of data collection (e.g., Dodds *et al.* 1996, Collins *et al.* 1998; Knapp & Smith 2001, Jonas & Joern 2007).**

During LTER VI, we will: (1) continue core long-term experiments focused on responses to land-use and climatic variability, with the addition of new treatments and response variables; (2) expand studies of woody plant encroachment into grasslands, a critical land-cover change, to include new consumer and ecosystem responses and add new paleoecological perspectives; (3) assess rates and trajectories of change during restoration of grasslands, an increasingly important land use; (4) expand climate change studies; (5) continue and expand long-term studies of nutrient enrichment and interactions with land-use practices, with new emphasis on linking above- and belowground responses; (6) initiate new studies on the consequences of altered nutrient regimes for streams, and on linkages between terrestrial land-cover change and streams; and (7) use KNZ data to support regional ecological studies and place our research in the context of regional socio-ecological systems. New LTER studies will examine the mechanisms driving trajectories and rates of biotic responses to environmental change, including human responses to these changes (e.g., conservation and restoration). Finally, we will continue to use LTER data to promote formal integration and synthesis to advance ecological understanding of this and other ecosystems. Achieving these goals will both advance basic ecological knowledge and address issues of societal importance (Lubchenco 1998, Chapin *et al.* 2001, Liu *et al.* 2007).

B. Conceptual Framework — Grasslands and Global Change. Grasslands are among the biomes most sensitive to an array of global change phenomena (Albertson & Weaver 1954, Samson & Knopf 1994, Reich *et al.* 2001b, Knapp *et al.* 2002, Shaw *et al.* 2002, Briggs *et al.* 2005, Sherry *et al.* 2007), with important consequences at local, regional and global scales. Temperate grasslands are the native vegetation of ~36% of the Earth's surface (Sala 2001), and one of the largest vegetative provinces in North America (Samson & Knopf 1994, Lauenroth *et al.* 1999). Tallgrass prairie is the most mesic and productive of the Central Plains grasslands, historically covering ~ 67 million ha. The productivity of these grasslands resulted in extensive cultivation, and <4% of the original tallgrass prairie remains (Samson & Knopf 1994). However, expansive areas of native prairie remain in the western portion of its

original range, including the 50,000-km² Flint Hills (Fig. 15) where relatively steep slopes and rocky soils prevented cultivation. These grasslands lie between forests to the east and more arid grasslands to the west, and are influenced by large-scale gradients in temperature and precipitation. These mesic grasslands would be dominated by trees without frequent fire. **Occurrence of tallgrass prairie in this dynamic ‘tension zone’ makes this ecosystem a sensitive indicator of climate change and other human-induced environmental changes** (Knapp & Smith 2001, Briggs et al. 2005)

The dynamic nature of tallgrass prairie affords unique opportunities for ecological study in the context of human-driven changes. Long-term research at Konza has established the importance of three critical ecosystem drivers – fire, herbivory and climatic variability – that interact to determine the structure (physiognomy, life-form dominance, species composition, biodiversity) and function (productivity, nutrient cycling, organic matter storage) of grasslands (Knapp *et al.* 1998) and their streams (Dodds *et al.* 2004). Whereas some ecosystems are constrained by chronic limitations of a single resource (*e.g.*, water in arid sites or N in more mesic biomes), dynamics in mesic grasslands are products of multiple limiting resources (water, light, N) that vary in response to fire, grazing, climatic regimes, site history and landscape position (Fig. 13; Seastedt & Knapp 1993, Turner *et al.* 1997, Briggs *et al.* 1998, Knapp *et al.* 1998, Nippert & Knapp 2007a). Thus, many ecological patterns and processes in mesic grasslands are best considered from a non-equilibrium perspective, where variable disturbances and frequent shifts in the relative importance of key resources are crucial for maintaining both diversity and ecosystem functioning (Seastedt & Knapp 1993). We will continue to address responses to natural disturbances in grasslands, but we also recognize that many global changes alter resource availability in novel ways. In many cases, these are chronic and directional changes in resources (*e.g.*, elevated CO₂, increased N deposition, warming, altered precipitation amount). These changes may push ecosystems along trajectories and at rates of change not encountered in the recent past. Indeed, data from long-term manipulations of resource availability at Konza have led to a model of hierarchical responses (Fig. 16) that provides one framework for assessing responses to chronic resource alterations due to global change (Smith *et al. in review*).

In summary, our conceptual framework recognizes that the drivers of ecological processes in grasslands are being altered by human activities, either directly through changes in land use and management, or indirectly through alterations in climate and nutrient inputs (Fig. 14). We expect shifts in relative resource supply and limitations associated with these changes to result in significant and measurable responses (*e.g.*, directional changes) in grasslands, with broader ecological implications for other ecosystems defined by non-equilibrium conditions and multiple limiting factors. **Hence, the long-term research program initiated >25 years ago to understand the effects of “natural” disturbances in this grassland remains current, and has additional and immediate relevance for understanding and predicting the consequences of global change taking place in the grasslands of North America, and around the world.** Examples of questions we will address in LTER VI include:

1. *How do the key natural and anthropogenic drivers of ecological change in tallgrass prairie impact organismic to ecosystem responses? What mechanisms underlie or constrain observed changes?* We expect these grasslands to exhibit responses at multiple spatial/temporal scales and levels of ecological organization to changes in fire and grazing regimes, altered climate, and altered nutrient availability (Knapp *et al.* 2002, Fay *et al.* 2003, Briggs *et al.* 2005, Williams 2007).
2. *What are the trajectories (e.g., directional, non-linear) and rates of change occurring at population, community, ecosystem, and regional scales? What are the consequences of environmental change for critical ecological processes and ecosystem services?* LTER datasets are increasingly valuable for detecting and assessing consequences of natural and human-induced environmental changes (Briggs *et al.* 2005, Dodds & Oakes 2006, Nippert *et al.* 2006, Jonas & Joern 2007).
3. *To what extent can trajectories of ecological change (e.g., woody plant encroachment or non-native species introductions) be altered by management based on ecological principles? What are the trajectories and rates of recovery in grassland communities and ecosystem processes during restoration?* In some cases, a target ecological state may be achieved by manipulating disturbance regimes, such as fire frequency or the activity of grazers (Collins *et al.* 2002). However, there may

be thresholds of change beyond which historic disturbance regimes are no longer effective and more drastic measures are required to affect change (Briggs *et al.* 2005).

C. The Site, Experimental Design & Rationale for Long-Term Research at Konza Prairie

Our focal site is the Konza Prairie Biological Station, a 3487-ha temperate grassland with a continental climate characterized by warm, wet summers and dry, cold winters. Mean annual precipitation (835 mm) is sufficient to support woodland or savanna vegetation, and drought, fire and grazing are critical for maintaining this grassland (Axelrod 1985, Anderson 1990). The site is topographically complex (320 to 444 m asl), and soil type and depth vary with topography. Soils are silty clay loams, formed from thick colluvial and alluvial deposits ≥ 2 m in lowlands, while hillside and upland soils are much shallower (Ransom *et al.* 1998). These soils overlay up to 10 layers of alternating limestone and shale, contributing to the complex subsurface hydrology of the region (Macpherson 1996, Oviatt 1998).

Vegetation is primarily (>90%) native tallgrass prairie, dominated by perennial warm-season C₄ grasses (*e.g.*, *Andropogon gerardii*, *Sorghastrum nutans*, *Panicum virgatum* and *Schizachyrium scoparium*). Numerous sub-dominant grasses, forbs and woody species contribute to high floristic diversity. Konza biota includes ~600 plant, 40 mammal, >200 bird, 34 reptile and amphibian, 20 fish, and >700 identified invertebrate species. The entire watershed of Kings Creek, a USGS Benchmark Stream, is located on Konza. Gallery forests dominated by *Quercus* spp. and *Celtis occidentalis* occur along major stream courses. Several agricultural fields and restored prairies occur in the lower Kings Creek watershed. Overall, the site has key features representative of native tallgrass prairie, and areas representing contemporary land use practices.

The KNZ program continues to build upon a long-term database of ecological patterns and processes derived from a watershed-level experimental design initiated in 1972 (Fig. 17). This design includes replicate watersheds subject to different fire and grazing treatments, as well as a number of long-term plot-level experiments (Table 1). Within core LTER watersheds, permanent sampling transects are replicated (n=4) at selected topographic positions, where ANPP, plant species composition, plant and consumer populations, soil properties, and key above- and belowground processes are measured. Collection of diverse data from common sampling locations facilitates integration among research groups. Below we describe our watershed-level experimental design, and our rationale for focusing on fire, grazing, and climate.

Fire— Human alteration of fire frequency is a key element of global change in grasslands (Whelan 1995, Bowman 2005, Bond & Keeley 2005, Bond *et al.* 2005). Fire was important historically in tallgrass prairie (Daubenmire 1968, Vogl 1974, Bragg 1982, Knapp *et al.* 1998, Reich *et al.* 2001a), and is managed to inhibit woody plants and promote the cover and productivity of C₄ grasses for cattle production or conservation. Fire alters the structure and function of grasslands across multiple spatial and temporal scales. It changes the light and soil environment of emerging plants (Knapp & Seastedt 1986), altering plant phenology, physiology (Knapp *et al.* 1998), and demography (Dalglish 2007), plant-microbe and pathogen interactions (Hartnett & Wilson 2002, Garrett *et al.* 2006), while increasing ANPP and decreasing N availability, thereby impacting competition for light and N. These changes contribute to reduced abundance and richness of C₃ plants, reduced frequency of exotic species, and a concomitant decline in biodiversity (Collins *et al.* 1998, Smith & Knapp 1999, Briggs & Knapp 2001). Changes in vegetation structure, composition and tissue quality elicit changes in population dynamics, species composition and habitat use by aboveground consumers (Kaufman *et al.* 1998, Joern 2005, Powell 2006, Wilgers *et al.* 2006) and affect belowground invertebrates (Blair *et al.* 2000, Callahan *et al.* 2003, Jones *et al.* 2006, Jonas *et al.* 2007), mycorrhizae (Jumpponen *et al.* 2005) and soil microbes (Zeglin *et al.* 2007). Ultimately, fire suppression leads to woody encroachment and even conversion to forest, an ecosystem state change with immense ecological impacts (Briggs *et al.* 2005, McKinley *et al.* 2008).

The site-level experimental design at Konza (Fig. 17) includes replicate watersheds (avg. size = 60 ha) burned annually or at 2-, 4-, 10- and 20-yr frequencies, bracketing likely historic fire frequencies and contemporary management extremes. Most watersheds are burned in April at the end of the dormant season, when large fine fuel loads and high frequency of lightning occurred historically, and when prescribed burning occurs regionally (Bragg 1995). Because fires historically occurred at other times of

year (Engle & Bidwell 2001), we initiated a “season of fire” experiment in 1994, with replicate watersheds burned annually in spring, summer, fall or winter (Towne & Kemp 2003). In 2001, we initiated a long-term “fire treatment reversal” experiment (annual and 20-yr fire treatments switched on replicate watersheds) to provide new insights into trajectories and rates of change in plant and consumer populations and communities and soil processes in response to changing fire regimes, and the role of site history in responses to fire (see *Prior Results*). We also manipulate fire in long-term plot-level experiments on Konza, where detailed ecological responses and mechanisms underlying effects of fire and other manipulations are more readily addressed (*e.g.*, Callaham *et al.* 2003, Dell *et al.* 2005).

Grazing— Changes associated with the management of megaherbivores are among the most significant in the recent history of mesic grasslands worldwide (Fuhlendorf & Engle 2001, 2004, McNaughton 2001, Walker 2001), as grazers play a crucial role in the dynamics of grasslands (Collins *et al.* 1998, WallisDeVries 1998, Lemaire *et al.* 2000, Fuhlendorf *et al.* 2006, Frank 2007). Grazing by bison was historically important in tallgrass prairie, but cattle grazing is now the dominant land-use in the Flint Hills as in many other grasslands. To address the role of native grazers and interactions with fire (Hobbs *et al.* 1991, Johnson & Matchett 2001, Trager *et al.* 2004, Collins & Smith 2006), bison were reintroduced beginning in 1987 to a 1000-ha area of Konza that includes replicate watersheds burned at 1-, 2-, 4- and 20-yr intervals and a range of topography and vegetation types. Comparative studies of native (bison) vs. introduced (cattle) ungulates, and interactions with invertebrate herbivores (*e.g.*, grasshoppers) and other consumers (small mammals and birds) have been critical for understanding responses to changes in dominant grazers and associated management (Towne *et al.* 2005, Villarreal *et al.* 2006). At Konza, similarities and differences in ecological responses to bison and cattle grazing are being assessed by long-term comparisons at both the watershed and small enclosure (5 ha) scales.

Climate— North American grasslands were formed by climate changes originating during the Miocene-Pliocene transition (Bryson *et al.* 1970, Axelrod 1985, Osborne 2008), and their present day distributions depend on regional temperature and precipitation gradients (Sala *et al.* 1988, Lauenroth *et al.* 1999). Our studies of fire and grazing interactions are unique within the LTER network, but a long-term perspective has also underscored the pervasive effect of inter- and intra-annual climatic variability on grassland dynamics. For mesic grasslands, the mean and extremes of precipitation (floods and droughts) affect most ecosystem processes (Anderson 1990, Hayden 1998, Dodds *et al.* 2004), and precipitation variability affects productivity more in grasslands than in other North American biomes (Knapp & Smith 2001). Climate change predictions for the Central Plains include increased temperatures and increased temporal variability in rainfall (*i.e.*, larger storms and longer intervening dry periods; Gregory *et al.* 1997, Groisman *et al.* 1999, Easterling *et al.* 2000, IPCC 2007). Changes in temporal patterns of precipitation are predicted to impact grasslands more than changes in precipitation quantity alone (IPCC 2007). We are just beginning to understand how grasslands and their streams will respond to more extreme rainfall patterns (Knapp *et al.* 2002, Fay *et al.* 2003, Weltzin *et al.* 2003, Bertrand 2007). However, longer-term studies that consider multiple, interacting factors (*e.g.*, temperature and precipitation) are still needed to provide realistic assessments of responses to global change (Shaw *et al.* 2002, Dukes *et al.* 2005), and during LTER V we added warming to our precipitation manipulation experiment. New experiments for LTER VI will assess longer-term grassland responses to multiple climate change factors, as well as interactions of climate change and other global change drivers, over short- and long- time scales.

In summary, the KNZ conceptual framework incorporates fire, grazing, and climatic variability as essential and interactive factors shaping the structure and dynamics of grasslands across landscape mosaics. We will test specific hypotheses on the independent and interactive effects of these factors, and evaluate rates and trajectories of response to changing environmental drivers, and the mechanisms underlying those changes to enable forecasting the consequences of multiple global change phenomena.

D. Long- and Short-Term Experiments. Below, we describe ongoing and proposed new research for Konza LTER VI. We will expand our original core LTER initiatives under the following themes, chosen to foster integration across disciplines, biological levels of organization, and temporal and spatial scales of study: (1) Land-use and land-cover change, including (a) impacts of changing fire-grazing regimes (b) causes/consequences of woody plant expansion, and (c) ecosystem restoration; (2) Ecological responses to

climatic variability and climate change; (3) Responses to altered biogeochemical cycles in terrestrial grassland ecosystems; (4) Aquatic ecology and effects of altered water quality and hydrology; and (5) Regionalization, remote sensing, and modeling. Konza LTER activities within these research themes are coordinated within and across research groups (see *Project Management*), and include projects and datasets encompassing the original five LTER “core areas” as well as specific research foci outlined in this proposal. Many linkages exist among these research groups and their goals, and our short-term and plot-level experiments are integrated with core LTER experiments and long-term data (Fig. 18) enabling numerous opportunities for synthesis. (Note: investigators participating in specific research areas are listed in *Project Management*. Detailed methods for existing long-term studies are associated with individual datasets on the KNZ website – www.konza.ksu.edu).

D1a. Land-Use and Land-Cover Change: Fire and grazing as drivers of change in grasslands.

Long-term watershed-level fire and grazing studies – Altered fire regimes and the management of mega-herbivores are among the most significant drivers of ecological change in grasslands worldwide (Fuhlendorf & Engle 2001, McNaughton 2001, Walker 2001, Bond & Keeley 2005, Bond *et al.* 2005). Konza studies on the effects of fire and large grazers clearly show that (1) these drivers strongly interact to influence grassland dynamics, (2) many effects of fire-grazing interactions on these grasslands are mediated indirectly through alterations in other biotic interactions (*e.g.*, invertebrate herbivory, mycorrhizal symbiosis), and (3) ecological responses at many levels are strongly influenced by spatial patterns and heterogeneity in fire and grazing. Thus, spatio-temporal heterogeneity in fire-grazing interactions and effects on multiple biotic interactions in a changing environment will be a central focus of continuing long-term studies and new initiatives.

Konza watershed-level fire and grazing experiments will continue to be the foundation for our core LTER research. We will continue to measure ANPP, plant species composition, plant and consumer populations, soil properties, and key above- and belowground processes along replicate sampling transects within 17 core LTER watersheds, and to maintain long-term databases documenting these dynamics (See *Supplemental Material*). Spatial and temporal patterns and controls of ANPP will be assessed based on biomass harvests (Briggs & Knapp 1995). We will quantify the cumulative impacts of large grazers on production potential (recovery of productivity after cessation of grazing), and relate these responses to grazer-induced changes in plant community composition and belowground processes (nutrient availability, root dynamics and belowground meristems). Because bison graze in discrete patches that shift over time (Vinton *et al.* 1993, Knapp *et al.* 1999), assessing ANPP under alternating periods of herbivory and reduced grazing is appropriate. Since 1992, we have measured ANPP in 98 permanent grazing exclosures (5×5 m), and compared these data with estimates from temporary exclosures in adjacent plots historically exposed to grazing, but with grazers excluded for a 3-yr period. These long-term data will be complemented by new estimates of ANPP in the presence of active grazers using small, moveable exclosures sampled at 3-4 wk intervals throughout the growing season (N=60 per fire-grazing treatment; McNaughton *et al.* 1996).

We will continue long-term measurements of plant species composition (frequency and cover; Collins 1992), stem densities, fecundity, and belowground bud bank densities on LTER transects. These ongoing studies, along with new research will assess the independent and interacting effects of changing land use (fire and grazing regimes) on plant populations and communities at multiple scales (*e.g.*, Collins and Smith 2006), and test current theories on community structure and biotic interactions. We will assess rates and trajectories of community change, and relate these responses to mechanisms (*e.g.*, altered resource availability, biotic interactions), and ecosystem processes (*e.g.*, ANPP, nutrient dynamics).

New fire-grazing studies during LTER VI will focus on (1) effects of fire- and grazing-generated patch mosaics on landscape diversity of plants and consumers, (2) relationships between landscape heterogeneity, nutritional quality, and grazer distributions, and (3) consumer responses to spatio-temporal heterogeneity resulting from fire-grazing interactions. Related studies will assess (4) demographic processes driving grassland responses to environmental change, including fire and grazing regimes, and (5) the relationship of plant species traits to community change.

1. *Patterns and consequences of fire/grazing patch mosaics.* The shifting-mosaic model of grasslands posits that spatially and temporally heterogeneous grasslands result from non-equilibrium grazing-fire interactions, which in turn influence future grazing activity and fire intensity (Archibald *et al.* 2005, Fuhlendorf *et al.* 2006, Anderson *et al.* 2007). This model has led to recent changes in fire management in tallgrass prairie and other grasslands and savannas worldwide to emphasize increasing the spatial and temporal heterogeneity of fire regimes across landscapes (Fuhlendorf & Engle 2001, van Wilgen *et al.* 2003, Burrows & Wardell-Johnson 2004). Patch mosaic burning is used to create an assortment of patches of varying fire histories, with the assumption that fire heterogeneity maintains high levels of biodiversity (Brockett *et al.* 2001, Panzer 2003). An overlay of diverse grazing management strategies can further increase heterogeneity. An understanding of ecological response to fire-grazing patch mosaics and heterogeneity is important for predicting the consequences of ongoing and projected future land use changes in grasslands.

Two different levels of patchiness are generated by heterogeneous fire regimes, the *visible mosaic* that is composed of burned and unburned patches in recently burned landscapes, and the *invisible mosaic* that is composed of patches representing different fire histories (post-fire age) that vary qualitatively and quantitatively in key limiting resources (Gill *et al.* 2003). Grazing also generates a visible mosaic of patches (lightly grazed to intensively grazed “lawns”, and altered vegetation structure and composition) plus an invisible mosaic composed of patches of altered processes, including nutrient redistribution and cycling, soil-water relations and biotic interactions, generated by selective herbivory (Frank & Evans 1997, Augustine & McNaughton 1998, Augustine & Frank 2001, Johnson & Matchett 2001, Frank 2005).

Heterogeneity resulting from fire-grazing interactions is hypothesized to maintain a range of environmental conditions in space and time which, when coupled with differential species responses to fire, enables a large number of species to persist at the landscape level, thus conserving biodiversity. This hypothesis has significant implications for both management and conservation (Fuhlendorf & Engle 2006). However, a recent review (Parr & Anderson 2006) has questioned the “pyrodiversity begets biodiversity” hypothesis and its ecological consequences. We will test this hypothesis and address questions regarding the role and importance of fire heterogeneity in tallgrass prairies, focusing on both plant and consumer responses. Examples of questions to be addressed include: (1) *What is the relationship between fire heterogeneity and biological diversity in grasslands?* Parr & Andersen (2006) hypothesized that fire heterogeneity would have the least effect in ecosystems characterized by a high resilience in relation to fire. In contrast, we predict that fire heterogeneity in mesic grasslands, particularly that associated with the invisible mosaic, will have significant effects on biodiversity. (2) *Given the strong spatial interaction between fire and grazing in tallgrass prairie, how does heterogeneity generated by fire-grazing interactions influence patterns of diversity at the landscape scale?* (3) *How do different taxa respond to shifting patch mosaics in tallgrass prairie?* and (4) *How does heterogeneity in fire and grazing influence rates and trajectories of woody plant encroachment* (see section D.3).

To increase our understanding of the spatio-temporal dynamics of fire-grazing interactions, we will expand the watershed-level experimental design to include two new replicate grazing units, each encompassing a mosaic of individual watershed units (patches) subject to asynchronous prescribed fire and variable fire histories. The experiment will be initiated in 2010, after baseline sampling in 2008 and 2009, and will use two large landscape units (314 and 462 ha), each composed of three watershed units (Fig. 17: CA/B, CC, & CD; and SA, SB & SC). Three watersheds in each unit will be combined to form equally accessible sites to cattle with one watershed burned each year, where the time since last burn will rotate among watersheds. Thus, each landscape unit will have patches that reflect 0, 1 and 2 years since fire. These units will be grazed season-long by cattle at a stocking density of 4 ha/animal, a moderate density for this region and comparable to NPP removal rates in the bison units. We expect this shifting-mosaic habitat diversity to support an increased diversity of consumers, where taxonomic compositions among watersheds will change rapidly because of species-specific differences in habitat requirements. Plant species composition, ANPP, soil nutrients, and consumer responses will be measured at the same spatial and temporal scales and using the same methodology established for the core research protocols. We will also assess the impact of this management on water quality (dissolved organic C, total N and P,

and sediment export) by comparing water quality in streams draining the Shane Creek Units to comparable samples taken from streams draining bison areas on Kings Creek.

With these additional experimental treatments, Konza Prairie will consist of four different landscape types: (1) ungrazed landscape with patches (watersheds) burned at different frequencies (N=26), (2) ungrazed landscape with patches burned in different seasons (N=8), (3) landscape grazed by bison and with patches burned at different frequencies (N=10), and (4) landscape grazed by cattle and patches burned at different frequencies (N=6). Plant species richness and diversity in each landscape type will be quantified by generating species/area accumulation curves, and species diversity (H') curves. Quantitative community similarity indices will be calculated, and the inverse of the mean similarity among watersheds will be used as an index of beta diversity for that landscape type. Principal components analysis and non-metric multidimensional scaling will be used to assess patterns of diversity and similarity among watershed units and landscape types, and to extend a recent analysis of who examined the scale-dependency of fire and grazing effects on community heterogeneity (Collins & Smith 2006). We will use similar analytical approaches to evaluate the influence of fire-grazing mosaics on consumer communities.

2. Landscape heterogeneity, nutritional variation and bison distributions. Ungulate grazing creates heterogeneity that influences future grazing patterns and ultimately affects grassland processes across scales (Hobbs 1996, Nellis & Briggs 1997, Cid & Brizuela 1998). Grazers, in turn, make small- and large-scale foraging decisions based on food quality in a spatially heterogeneous nutritional landscape (Senft *et al.* 1987, Lima & Zollner 1996, Bailey & WallisDeVries 1998, Zollner & Lima 1999). During LTER VI, we will investigate determinants of bison and cattle distributions and foraging activities using GPS/GIS/remote sensing technology and on-the-ground herbivore surveys to assess their impacts in response to management activities, forage quality, habitat spatial heterogeneity, and other vegetation characteristics. Relationships to predict the distribution of plant biomass and forage quality using remote sensing can be developed for complex, mixed-species canopies such as tallgrass prairie (Mutanga & Skidmore 2004ab, Ferwerda *et al.* 2005, Mutanga *et al.* 2005, Ferwerda *et al.* 2006, Mutanga & Rugege 2006, Phillips *et al.* 2006). New research will assess the role of temporally and spatially heterogeneous forage quality (*e.g.*, total biomass and nutrient content) and vegetation structure in modulating grazer foraging decisions, using broadband and hyperspectral remote sensing and GIS technology at a 1-m scale to map distributions of forage quality and grazing animals (Fig. 19). Periodic herbivore surveys will provide additional information about distributions and behavioral responses to fire regimes and forage quality.

3. Consumer responses to fire/grazing and spatio-temporal heterogeneity: long-term patterns and underlying mechanisms. Long-term studies of consumer responses to fire-grazing treatments at Konza have focused on grasshoppers, birds and small mammals – representative consumers that differ in ecologically important traits, including trophic levels, size, metabolic capabilities, and vagility. A unifying theme of our consumer studies is the importance of directional changes and variation in habitat structure and spatial heterogeneity for understanding consumer responses to fire and grazing. We will continue to measure responses of consumers to land management practices and spatio-temporal habitat heterogeneity using established LTER protocols. Long-term data reveal strong species-specific responses by consumers to changing fire, grazing and weather (Powell 2006, Jonas & Joern 2007, Reed *et al.* 2007), and indicate the need for new demographic studies, linking organismic responses to spatial and temporal heterogeneity, to enable better predictions of consumer population responses to future environmental conditions.

Insect herbivores – Insect herbivores are functionally important and contribute to grassland diversity. We predict that visible and invisible habitat mosaics (see above) will greatly affect insect consumer populations and species assemblages. Studies begun during LTER V to delineate mechanisms responsible for observed temporal patterns (Joern 2004, 2005) and the functional role of grasshoppers, a dominant insect herbivore in tallgrass prairie (Meyer *et al.* 2002), will continue. New studies will be initiated in the patch burning/grazing experiment. Long-term KNZ data on grasshopper abundances indicate that fire, grazing and weather (including decadal climatic patterns) have major impacts on grasshoppers (Jonas & Joern 2007). Estimates of grasshopper performance (annual mass gain and reproduction (oöcyte analyses), and stage-dependent density responses) will be obtained for different fire-frequency-grazing treatments

over replicated sites for each year of LTER VI. Species composition and diversity of local assemblages, and species abundances will be estimated (Joern 2004, 2005). Critical habitat attributes to be measured include foliar nutritional quality at sites, vegetation composition and structure, and environmental heterogeneity. Structural equation models will be used to synthesize results (Fig. 20; Joern 2005).

Grassland birds – Many grassland bird populations are in significant decline. We will maintain LTER bird surveys to assess avian responses to environmental change and extend a 7-yr demographic study of the Upland Sandpiper (*Bartramia longicauda*) as a model to assess how spatially variable management affects avian population responses. Survey data indicate that sandpipers are most abundant in recently burned sites (Fig. 21; Powell 2006), but sandpipers prefer to nest in unburned and ungrazed areas where nest survival is higher (Sandercock, *radio-tracking data*). Migratory animals often have low fecundity and high survival (Sandercock & Jaramillo 2002), and require long-term study to estimate demographic parameters (Sandercock 2006). Upland Sandpipers require native grasslands for breeding, and considerable age-specific demographic data are now available to assess long-term project needs (Mong & Sandercock 2007). However, longer time series are needed to model demographic parameters as a function of environmental covariates (Collins 2001), to quantify the statistical distributions underlying the demographic parameters (Fieberg & Ellner 2001), and to estimate process variance (Gould & Nichols 1998). Therefore, our long-term goals include continuing the focal breeding study at Konza.

Small mammals – Variation in habitat heterogeneity, structure and weather conditions are critical proximal drivers of small mammal spatial and temporal dynamics. Small mammals track environmental variability and directional changes rapidly (Kaufman & Kaufman 1997), and demographic studies coupled with long-term monitoring can provide insights into effects of global change. Long-term small mammal censuses at Konza provide critical data to assess the contributions of weather, net primary productivity, fire, and grazers on temporal variation in abundance. They also address the effects of frequency and season of fire, grazing, weather, and influence of woody species expansion on small mammal populations and communities. Primary questions for small mammal studies in LTER VI include: (1) Are the impacts of fire mediated primarily through the effects on habitat structure (*e.g.*, litter layer depth or invasion of woody vegetation)? (2) What are the contributions of temperature and precipitation to small mammal abundances? and, (3) What is the relative importance of habitat spatial and temporal heterogeneity to population abundance and species diversity of small mammal communities?

4. *Demographic processes driving grassland responses to changing fire/grazing regimes: the role of bud banks.* Plant population studies link organismic through ecosystem-level phenomena, and elucidate mechanisms underlying plant biodiversity and responses to global change. In tallgrass prairie, most aboveground plant recruitment comes from belowground meristems rather than from seeds (Benson & Hartnett 2006, Rogers & Hartnett 2001) so that “bud banks” play a key role in plant community structure, stability, and invasibility. We will address the following questions and test new hypotheses about the role of bud banks in grassland responses to fire-grazing interactions and environmental change: (1) How does the maintenance of a belowground bud bank (and its size) influence long-term population dynamic behavior and productivity dynamics? (2) Is the bud bank a stabilizing or de-stabilizing influence on grassland dynamics in response to environmental change? (3) How do reserve bud bank populations influence responses to fire-grazing interactions?

Regular ramet/tiller recruitment from belowground bud banks may stabilize population dynamics (Kingsolver 1986, Hartnett & Keeler 1995), influencing rates and trajectories of plant community responses to disturbance or environmental change. Perennial grass populations can show unstable dynamics driven by litter accumulation and resultant time lags in nutrient cycling that influence tiller emergence from the bud bank (*e.g.*, Tilman & Wedin 1991, Pastor 2006). We will test the hypothesis that fire and grazing, through litter removal can stabilize plant population dynamics and buffer populations against other environmental changes. Quantifying these dynamics is important since unstable dynamics of dominant species affect variability in ANPP, and unstable dynamics of rare species may increase their extinction risk under rapid environmental change. The >25-yr record of plant species abundances, coupled with new sampling of bud bank populations along LTER vegetation transects will allow us to examine the relationship between bud bank densities and long-term population dynamic behavior.

Five grass species (*A. gerardii*, *S. nutans*, *P. virgatum*, *D. oligosanthos*, *E. canadensis*) will be sampled annually at the end of the dormant season across a range of fire-grazing treatments to determine mean and variability in bud bank densities and effects of grazing and fire on bud bank populations and floristic diversity. Population dynamics of each species (stable, damped oscillations, cycles, chaos) under each treatment combination will be quantified from LTER datasets by calculating the CV of population abundance among years, and from growth model parameters (discontinuous growth model with density-dependence) and recruitment curves (N_{t+1} vs. N_t). Relationships between bud bank size and population dynamics will be assessed for each species by regressing model parameters against bud bank density. We will also build stage-based matrix population models for these species (Fig. 22) and use sensitivity/elasticity analyses to assess the importance of bud banks for population dynamics.

5. Plant species traits and community structure. Species abundances across environmental gradients reflect abilities to acquire limiting resources, endure and respond to environmental stresses, resist disturbance from fire or herbivory, and/or disperse. New LTER research will investigate the relationships between plant functional traits and plant community structure, with emphasis on explaining plant species responses to environmental variation and change (Aerts & Chapin 2000, Craine *et al.* 2001, McGill *et al.* 2006, Westoby & Wright 2006). Using controlled greenhouse and field experiments, we will characterize plant traits related to the nutrient, water, and light economies of plants (*e.g.*, root tissue density, minimum water potentials, xylem characteristics, whole-plant light compensation points and maximum relative growth rates) for a suite of herbaceous species at Konza. By growing plants over a range of controlled environmental conditions, we will be able to test the ability of plant functional traits, assessed independently of specific environmental conditions, to explain species performance along environmental gradients and in response to environmental change, as revealed by LTER plant species composition data.

D1b. Land-Use and Land Cover Change: Causes and consequences of woody plant expansion in grasslands. Increased cover and abundance of woody species is a significant consequence of changing land-use practices, and a growing threat to grassland conservation in the Central Plains and other grasslands and savannas worldwide (Archer *et al.* 1995, Brown & Carter 1998, Moleele & Perkins 1998, Knapp *et al.* 2008). Tallgrass prairie at the western limits of its range (*e.g.*, the Flint Hills) is particularly responsive to shifts in climate, land management and fire regimes (Knight *et al.* 1994, Briggs and Gibson 1992, Hayden 1998, Briggs *et al.* 2005), making it well suited for studying grassland to forest transitions. Expansion of trees and shrubs in prairie without fire has been long recognized (Gleason 1913), but the consequences of moderate alterations in fire regime are not well understood, nor is the potential for restoring grasslands after conversion to shrub/tree dominance. Our long term datasets provide a synoptic perspective of the transition from a C_4 graminoid ecosystem to one dominated by C_3 woody plants (Figs. 8 and 23), and offer a unique opportunity for identifying drivers of change, mechanisms of woody plant expansion and persistence, and ecological consequences. We will expand existing LTER data to document long-term patterns of shrub expansion and begin new studies to refine our understanding of the causes and consequences of this land-cover change, with a focus on the role of fire, grazing and climate.

1. Long-term assessment of the nature & pace of shrub expansion in a grassland matrix. We used LTER data to quantify patterns of change in upland shrub cover, frequency, and species richness under different fire frequencies (Heisler *et al.* 2003). From 1983 to 2000, shrub cover increased by 29% in sites burned every 4 yrs, and 24% in sites burned only once in 18 yrs. While annual spring fires effectively prevented recruitment of new woody plant species, shrub cover still increased slightly (4%). Native shrub species richness doubled (from 3 to 6 species) under intermediate and low fire frequencies. Other larger-scale studies of woody plant cover at Konza use transect-level ground mapping on core LTER watersheds (Fig. 23), historical aerial photographs, and remote sensing at 20-m resolution. During LTER VI, we will employ a new fractal net evolution approach (FNEA), an object-oriented segmentation algorithm embedded in the software eCognition (Baatz & Schäpe 2000, Definiens 2003) of Konza Prairie using Quickbird© images (< 1 m resolution). This method classifies woody vegetation using remote sensing and a hybrid approach of image segmentation and classification based on spectral and contextual values (Blaschke & Hay 2001, Walker & Briggs 2007). FNEA, used successfully at the Jornada LTER site (Laliberte *et al.* 2004), employs cadastral information (*i.e.*, within-pixel spectra values and patch texture) and neighborhood characteristics to extract real-world objects as the basic units for analysis.

During LTER V, we expanded studies of net ecosystem C exchange to include 3 eddy flux towers, allowing comparison of C fluxes from (1) different landscape positions (uplands vs. lowlands); (2) different land-uses (annual vs. intermediate fire frequencies), and (3) different land-cover (grass-dominated vs. grass-shrubland). The expanded spatial coverage of net C exchange studies on two core LTER watersheds will allow us to compare net C exchange, components of C flux (*e.g.*, leaf-level assimilation, ANPP, soil CO₂ flux), and biotic and abiotic controls on watersheds with low and high woody plant cover. Another new LTER VI initiative will focus on the impacts of woody plant expansion on grassland streams (see riparian woody plant removal experiments in section D4).

2. *Gallery forest expansion into a grassland landscape.* In the central Great Plains, closed canopy forests of deciduous trees were historically patchily distributed within native grasslands, occurring in narrow bands on alluvial soils along streams or in low-lying drainages (Knight *et al.* 1994). Forests cover in eastern Kansas has increased since the mid-1800's (Bragg & Hulbert 1976, Abrams 1986, Knight *et al.* 1994). Gallery forest on Konza increased 72% from 1939 to 2002 (Fig. 24; Briggs *et al.* 2005). Ecological factors limiting the distribution of trees at Konza likely include a combination of resource availability (Danner & Knapp 2001), competition (Abrams 1992), and seed/sapling predation (Stapanian & Smith 1986, Schnurr *et al.* 2002, van der Hoek *et al.* 2002, Norman & Steffen 2003). Current forest age structure may also be a legacy of historic management including fire suppression (Bragg & Hulbert 1976, Abrams 1985), grazing (Ripple & Beshta 2007), and selective cutting and herbicide use (Abrams 1986).

We will examine the roles of climatic variability, herbivory, and fire on the population dynamics of deciduous trees in gallery forests. Because many of these trees are slow-growing and long-lived (>80 yrs, Abrams 1986, Ripple & Beshta 2007), we propose a long-term monitoring approach to examine spatial and temporal patterns of productivity and stage-specific variation in survival. We will: (1) use historical distribution, aerial photographs, and new remotely-sensed images to define gallery forest boundaries and dynamics (Knight *et al.* 1994, Briggs *et al.* 2005); (2) determine demographic transition rates, changes in species composition and spatial cover with censuses that map individual tree location and stage class (seedlings, saplings and tree) and variability in seed production, including mast years; and (3) evaluate germination rates and effect of herbivory on seedling recruitment and survival using herbivore exclosures.

A new dendroecological retrospective will provide further insights into long-term patterns and drivers of change (McLachlan *et al.* 2007). We will test the hypothesis that N and water availability have changed throughout the period of woody expansion, impacting the establishment and growth of woody species. To test this hypothesis, we will reconstruct historic N availability using stable N isotopes, N concentration, and ring widths in trees. The project will produce data on: (1) age structure of tree populations (individual *bur oak* trees may be > 145 yrs); (2) patterns of ring-width (for integration with regional climate records); (3) historic disturbances such as severe fires, and (4) N availability over time. At each site, duplicate increment bores from clusters of trees will be identified, permitting analysis of similarities within a cluster. Scanned images will be analyzed to cross-date trees and obtain ring widths. Core sections (30 mg representing ~2.75 yrs) will provide N samples for isotopic analysis at maximum temporal resolution. Isotopic values will be standardized and analyzed as in McLachlan *et al.* (2007).

D1c. Land-Use and Land-Cover Change - Grassland restoration: Trajectories of change during ecosystem recovery. Grassland restoration is increasingly important in the Central Plains, and provides a unique opportunity to apply and test ecological theory. Restoration generally aims to reassemble plant communities and restore key ecosystem processes. During LTER VI we will continue established restoration experiments to assess long-term trajectories of change in plant community composition and ecosystem properties (Baer *et al.* 2004, 2005; Baer & Blair *in press*), and begin new research to understand how variation in environmental conditions at the onset of restoration influences long-term trajectories of recovery. Ongoing restoration studies at Konza comprise three field experiments that include manipulations of (1) soil resource availability and heterogeneity, (2) biotic interactions between plants and mycorrhizae, and (3) C₄ grass seed source (local ecotypes vs. cultivars) and seeded species dominance. Continuing these experiments will address the role of environmental heterogeneity in community recovery and differential changes in soil C and N recovery under varying nutrient regimes; the degree to which plant-mycorrhizae interactions influence plant diversity, soil aggregate stability, and rates

of soil C accumulation; and the effects of intraspecific variation and initial species pool on community and ecosystem recovery.

Understanding processes that constrain the arrival and persistence of species in a community has long interested ecologists (Diamond 1975, Keddy 1992, Lockwood *et al.* 1997, Belyea & Lancaster 1999, Weiher & Keddy 1999). Assembly “filters” can be deterministic or stochastic (biotic and/or abiotic) factors that either prevent recruitment or “sift” species out of a community (Weiher & Keddy 1995, Zobel 1997, Hobbs & Norton 2004, Lockwood & Samuels 2004). Identifying the role of deterministic processes (*i.e.*, soil heterogeneity, nutrient availability, and available species pool) was the primary focus of restoration studies during LTER V (Baer *et al.* 2003, 2004, 2005). In LTER VI, we will focus on the role of inter-annual variation in abiotic factors (*e.g.*, timing and amount of precipitation, temperature) and biotic interactions (*e.g.*, herbivory and mycorrhizae) on restoration trajectories (Hobbs & Harris 2001, Adler *et al.* 2006, Harris *et al.* 2006). We will initiate a restoration chronosequence by seeding recently cultivated 50 × 50-m plots (n=4) with locally harvested species every two years (3 separate initiations during LTER VI). Species composition and seeding densities will be held constant each year, and establishment of plots every two years will impose natural variation in initial conditions. Two community components that influence grassland plant diversity (Hartnett & Wilson 2002, Howe & Lane 2004) will be manipulated (fungicide application to suppress arbuscular mycorrhizal fungi (AMF) and fencing to exclude small mammals) in small subplots within each restoration plot. Response variables will include plant community composition, ANPP, changes in soil structure and function [soil aggregation (Mikha & Rice 2004), soil microbial community composition (phospholipid (PLFA) and neutral lipid fatty acid (NLFA) analyses; White & Ringelberg 1998), nematodes (Yeates *et al.* 1993), AMF root colonization and extraradical mycorrhizal hyphae (McGonigle *et al.* 1990, Miller *et al.* 1995, Johnson *et al.* 2003)] and small mammal abundance. Over the long term, the chronological sequence of restorations with similar soil type, land-use history, seeding rates, species pools, and management will be used to (1) more accurately quantify rates and trajectories of ecosystem recovery relative to other chronosequence studies (Jastrow *et al.* 1998, Baer *et al.* 2002, McLauchlan *et al.* 2006), and (2) provide insight into abiotic and biotic constraints on diversity and reproducibility of re-assembled prairie communities, where diversity is often much less than in native prairie (Maina & Howe 2000, Polley *et al.* 2005, Martin *et al.* 2005).

D2. Climate variability and climate change as a driver of ecological change in tallgrass prairie.

Climate is not amenable to manipulations at a watershed scale. Rather, we use a 3-part approach to address ecological responses to climatic variability and predicted directional climate change: (1) retrospective analyses of long-term data sets of climate variability and ecological responses (Knapp & Smith 2001, Knapp *et al.* 2006, Nippert *et al.* 2006); (2) smaller-scale manipulative experiments (Knapp *et al.* 2001, Fay *et al.* 2003, Harper *et al.* 2005, Swemmer *et al.* 2006, Nippert *et al.* 2007); and (3) use of existing spatial gradients (at both local and regional scales) in climate and associated resources (*e.g.*, soil moisture). Ecological responses to both local micrometeorological gradients and regional climatic gradients can be used to assess controls of ecosystem processes and to infer future responses to climate change (Briggs & Knapp 1995, Nippert & Knapp 2007a, b). We will continue core long-term watershed-level measurements in order to expand the temporal-scale and range of climatic conditions covered.

The KNZ program has a long history of manipulative experiments focused on ecological responses to climatic variables, especially temperature and water (Knapp 1984, Hulbert 1988). Currently, two long-term Konza experiments manipulate key climatic drivers: (1) the Irrigation Transect Study with altered soil water availability (17-yr study, 1991-present), and (2) the RaMPs Experiment with altered growing season precipitation patterns and canopy temperature (10-yr study, 1998-present). With 10+ yrs into each project, these experiments continue to further our understanding of the consequences of climate change and altered resource availability, and to serve as valuable platforms enabling additional research (see *Results from Prior Support* and D3). We will continue to support both as part of LTER VI.

The Irrigation Transect Experiment is a replicated water supplementation experiment designed to alleviate growing-season water stress across upland and lowland topographic positions in annually burned tallgrass prairie (Fig. 25; Knapp *et al.* 2001). We assess the degree of water limitation by comparing irrigated and control transects, and perhaps more importantly, assess the consequences of minimizing

interannual variability in soil moisture. Response variables include ANPP, plant species composition, and a suite of belowground responses (water content, chemistry, root biomass C and N, soil biota). Questions we will address include: Does the relationship between productivity and precipitation change as plant species composition shifts in response to long-term irrigation? Can high productivity be maintained by irrigation under an annual fire regime that promotes N loss by volatilization? What are the changes in soil C and N processes and pools in response to sustained irrigation?

The Rainfall Manipulation Plot (RaMPs) Experiment (Fay *et al.* 2000) addresses two important aspects of regional climate change (increased precipitation variability and temperature) and their interactions within a unique experimental facility (see Fig.9). This experiment was initiated primarily with non-LTER funds, but a modest investment of LTER resources has paid huge dividends (see *Results from Prior Support*) and will continue in LTER VI. Our central hypothesis is that warming (initiated in 2003) and more extreme rainfall patterns (larger precipitation events with longer inter-rainfall droughts, but no change in total precipitation amount) will significantly alter temporal patterns and depth distributions of soil moisture and, consequently, plant, community and ecosystem attributes and processes. Combined effects of more extreme precipitation patterns and warmer temperatures are predicted to be additive, but more complex interactions are likely for several key processes such as decomposition and soil CO₂ flux (Luo *et al.* 2001). These responses are integral for relating community and ecosystem responses to climate changes that include both directional changes and greater variability. Questions we will address include: (1) Will long-term (10 yr) trajectories of change continue at the same rate as initial responses, or will non-linear responses occur as ecological thresholds are crossed (Fig. 16)? (2) Will soil organic C and N pools decline over decades in response to altered rainfall patterns and more extreme wetting and drying cycles? (3) Will plant community changes (already occurring) lead to greater diversity of forbs or greater dominance by C₄ grasses? (4) How will ecosystem function (*e.g.*, the ANPP- precipitation relationship) change as plant species composition changes? This latter question is multi-factorial and includes both alterations in abiotic drivers and biotic structure in terrestrial ecosystems. The RaMPs experiment is unique among field experiments worldwide in focusing on the interactions of changes in climatic variability (precipitation) and climatic means (temperature) in a long-term experimental framework.

Microbial community responses to rainfall and temperature manipulations. During LTER V, we used PLFA to assess microbial community responses to irrigation (Williams 2007), and initiated a massively parallel sequencing (MPS; Margulies *et al.* 2005) approach for analyzing microbial responses to treatments in the RaMPs experiment (Knapp *et al.* 2002). Preliminary analysis indicates shifts in bacterial composition and decreased bacterial species richness in response to elevated temperature accompanied by less frequent rainfall (Jones *et al. unpublished data*). Of the 300 most abundant bacteria, 15 (5%) responded to manipulations. Neither eukaryotic richness nor diversity changed, but 14 of the 200 most abundant eukaryotes (7%) responded to altered precipitation (Jumpponen *et al. unpublished data*). This will be one of the most comprehensive microbial community characterizations to date in an LTER framework. Our goals for LTER VI are to apply MPS and complementary approaches (*e.g.*, PLFA; Fig. 26) to address microbial community responses (changes in community composition and separation of active and dormant microbial communities via RNA and DNA assays) to environmental change, including experimental climate manipulations. We will employ similar approaches to assess, microbial community responses to long-term nutrient enrichment in the Belowground Plot Experiment (See D5).

Environmental heterogeneity and plant responses in a tallgrass prairie landscape. New measurements along spatial gradients in key environmental conditions (*e.g.*, soil moisture, light) will address fine-scale spatial variability as a driver of ecological processes, and provide insight into responses to current climate variability and future climate change. Annual productivity and cover of the dominant C₄ grasses reflects independent and interactive responses to environmental variability (Risser *et al.* 1981, Knapp 1984, Turner *et al.* 1995, Turner & Knapp 1996, Knapp *et al.* 1998, McAllister *et al.* 1998, Nippert *et al.* 2007), resulting from climate variability (Briggs & Knapp 1995), management (fire and grazing) (Gibson 1988, Vinton *et al.* 1993, Hartnett *et al.* 1996), landscape heterogeneity (Gibson 1988), and seasonal phenology (Coppedge *et al.* 1998). Physiological responses of C₄ grasses to these drivers generally reflect shifting resource limitations (light, water and N; Blair 1997) and local environmental conditions (*e.g.*, air and soil temperature). Relationships between environmental variability and C₄ grass

responses have been a foundation for interpreting patterns and processes in tallgrass prairie, but the mechanisms influencing richness, diversity, and productivity of the subdominant C₃ forbs and grasses in response to environmental variability are poorly understood (Damhoureyeh & Hartnett 1997, Coppedge *et al.* 1998, Briggs & Knapp 2001). Unraveling C₃ forb and grass responses to variability in resources and environmental stresses requires species-level information on fire intensity, grazing, temporal climatic variability, topography, and interactions with the dominant C₄ grasses (Damhoureyeh & Hartnett 1997, Briggs & Knapp 2001). Thus, our ability to predict *future* plant-environmental interactions is constrained by incomplete information of plant responses to *current* environmental variability at relevant scales.

This new LTER initiative will establish permanent paired high resolution environmental monitoring stations to investigate the role of local environmental variability on species coexistence, resource competition, and landscape patterns of diversity and productivity. Multiple sensors connected to a central datalogger will characterize the local abiotic environment, including near surface soil (5cm) and air temperature, soil water content at depth (5, 20 and 40 cm), light intensity, windspeed, and humidity at 30-min intervals. We will continuously monitor local changes in water, light, and temperature to guide interpretations of plant responses over time. Landscape features of interest include: (1) topography, landscape position and aspect known to be key determinants of local environmental conditions and species responses (Knapp *et al.* 1993); (2) woody expansion; and (3) riparian canopy, the riparian corridors adjacent to the streams vary in tree density and canopy cover and influence the microclimate for both terrestrial and aquatic communities. We will characterize the local abiotic environment in permanent replicated plots (5×5 m) at each location while measuring the following plant responses: *physiological*-gas exchange rates, chlorophyll fluorescence, and leaf water potential; *population* – stem density; *community* - annual productivity, community diversity, and leaf area index. Investigating the role of heterogeneity (both biotic and abiotic, *Section D1a*) will provide insight into individual mechanisms, traits, and responses contributing to the patterns of community structure and ecosystem processes, as well as the physiological responses from changing resource availability across multiple scales.

Consumer responses to climatic variability and climate change. Global change can affect organisms by changing distributions, extending growing seasons, or altering the seasonal phenology of movement or reproductive events (Walther *et al.* 2002, Parmesan & Yohe 2003). Changes in timing of precipitation impacts stream organisms via flooding or drying, especially in intermittent grassland streams (Dodds *et al.* 2004). In terrestrial environments, changing climatic conditions during the summer may impact the activity periods or development rates of ectotherms such as arthropods and herpetofauna. Similarly, winter climate affects the demography of endotherms, particularly small-bodied animals or populations at the periphery of their range. The effects of global change also may be mediated by biotic interactions (Brown *et al.* 1997, Harrington *et al.* 1999, Suttle *et al.* 2007). Understanding how abiotic and biotic factors will combine with species interactions to determine organismal responses to global climate change remains a key knowledge gap in population and community ecology (Agrawal *et al.* 2007). The following new LTER VI consumer research aims to provide mechanistic explanations for observed relationships between climatic variability and consumer responses from long-term Konza data.

Arthropods – We will experimentally examine how abiotic and biotic factors influence species interactions in the context of directional climate change, as mediated by changes in temperature and plant quality on arthropod-based tri-trophic interactions (Oedekoven & Joern 2000, Danner & Joern 2003, 2004). New field experiments and comparative studies using a representative grassland food chain (plants-grasshoppers-spiders) will explore the dynamic tri-trophic interactions among temperature, food quality, predation risk, and herbivore density. We will extend current predictions about impacts of consumer responses to climate change by including responses at higher trophic levels, and assessing when and how indirect biotic interactions modify food webs responses. In a new field experiment (Fig. 27), we will manipulate temperature, host plant quality, risk to spider predation and herbivore density and follow their effects on grasshopper performance, the existence of trophic cascades, and the nature of direct and indirect interactions on primary production and N-cycling rates. The relative importance of direct and indirect interaction pathways will be identified with a large comparative study of grasshopper species to variation in habitat characteristics over multiple years, using both structural equations models (Grace 2007) and inferential approaches to synthesize results.

Small mammals – Deer mice are important consumers in grasslands (Reed *et al.* 2004a, 2005a, 2006b, Ross *et al.* 2007) and can respond rapidly to climate change, as weather conditions determine the onset and number of breeding seasons per year, and affect the survival of neonates and juveniles (Kaufman 1990). Population models for deer mice in mixed grass prairie show that rates of population change (λ) are highest in years with normal rainfall, but are reduced in more extreme years with either low or high rainfall (Reed *et al.* 2007). As a result, stochastic models predict that deer mice could be extirpated from mixed grass prairie under several climate change scenarios. In order to refine these population models and their ability to forecast responses to environmental change, new research will focus on demographic responses of deer mice to inter- and intra-annual climate variability and land management. To determine fecundity and survival rates, we will monitor artificial burrows year-round, live-trap animals within sampling grids, and uniquely mark individuals with PIT tags (Kaufman & Kaufman 1989, Rehmeier *et al.* 2006). Demographic parameters (litter size, sex ratio, growth rate, body size) will be assessed every 7-10 days (less often in winter) using artificial burrows in replicate watersheds burned in different seasons. Size-structured population models will be used to synthesize data and provide a mechanistic basis for projecting effects of climate change and interactions with season of fire on small mammal populations.

D3. Terrestrial ecosystem responses to altered biogeochemical cycles. Changes in biogeochemical cycles are both a cause and consequence of global change (Schlesinger 1997), with feedbacks that affect ecosystem processes, atmospheric chemistry, and water quality. Konza biogeochemical studies will continue to focus on (1) quantifying rates of nutrient input and export and internal dynamics, (2) evaluating the effects of fire, grazing and climate on nutrient cycling, (3) assessing responses to nutrient enrichment, and (4) linking changes in nutrient cycling to ecosystem and community responses. We will continue: long-term studies of atmospheric deposition (described below) and hydrologic export of nutrients (see Aquatic Studies); effects of land-use/land-cover on soil properties and processes (Lett *et al.* 2004, Norris *et al.* 2007) and plant nutrient content; and effects of altered climate on nutrient cycling (Harper *et al.* 2005). We will also continue assessing the effects of fire and grazing on spatial and temporal patterns of soil nutrient availability, and relationships to plant and consumer responses (Bakker *et al.* 2003, Veen *et al. in press*). Here we focus on quantifying nutrient inputs and responses to altered nutrient availability, especially N and P. We will continue core long-term nutrient enrichment experiments, including the *Belowground Plot Experiment* (22-yr study), the *Water \times N Experiment* (8-yr study) and the *P Addition Experiment* (5-yr study). New research will include (1) an intensive assessment of the impacts of long-term N enrichment on above and belowground communities, (2) a *N Press-Pulse Experiment*, and (3) an assessment of multiple resource limitations and bottom-up vs. top-down controls on grassland community structure and ecosystem functioning (*the Nutrient Network Experiment*).

Nutrient inputs and outputs. Long-term data on nutrient inputs are essential for constructing nutrient budgets, calculating weathering rates, and for assessing interannual variability and directional changes in nutrient loading (Gilliam 1987, Blair *et al.* 1998). We will continue collaborating with the National Atmospheric Deposition Program to document inputs of NO_3^- , NH_4^+ , SO_4^{2-} , PO_4^{3-} , H^+ and major cations in wetfall, and will continue our own long-term measurement of N and P inputs in bulk precipitation. We will support measurement of dry deposition (aerosols and fine particulates) as part of CASTNet (www.epa.gov/castnet), including weekly concentrations of SO_4^{2-} , NO_3^- , NH_4^+ , SO_2 , and HNO_3 , hourly concentrations of ambient O_3 and meteorological data to calculate dry deposition rates. A new initiative for LTER VI will be collection of the larger particulate component of dry deposition, using passive aerosol collectors to quantify dust deposition (see section D6). We will continue long-term measurements of N and P in stream water and groundwater to link terrestrial and hydrologic studies (see section D4).

Belowground Plot Experiment (1986-present). The Belowground Plot (BGP) Experiment provides a common platform for research on belowground processes and responses to fire, nutrient inputs (N, P or N+P) and mowing (Fig. 28). Response variables included ANPP, species composition, root dynamics, soil invertebrates, mycorrhizae, decomposition, soil microbial biomass and activity, soil solution chemistry and selected soil nutrient pools. We will maintain the BGP treatments for LTER VI, with annual measurements of ANPP and 5-yr measurements of plant community composition and soil chemistry. New research for LTER VI will include an intensive, synoptic sampling of above- and belowground communities and food webs, including: aboveground insects (Evans *et al.* 1983, Fay 2003, Joern 2004),

soil invertebrates (Todd 1996, Coleman *et al.* 1999, Callahan *et al.* 2003), root biomass and tissue chemistry, mycorrhizal colonization and communities (McGonigle *et al.* 1990, Helgason *et al.* 1998, Johnson *et al.* 2003), and soil microbial communities (Roesch *et al.* 2007). To assess long-term changes in soil microbial communities, we use complementary approaches, including fatty acid analysis (PFLA and NFLA) for broad microbial community changes (White & Ringelberg 1998), coupled with new genetic approaches (see Section D4) for fine-scale shifts in soil archaea, eubacteria and microeukaryotes.

P Addition Experiment (2002-present). Nitrogen strongly controls plant productivity, but P can affect ecosystem processes. Many prairie plants, particularly dominant C₄ grasses, are mycorrhizal dependent (Hetrick *et al.* 1994, Johnson *et al.* 1997, Hartnett & Wilson 2002), with AM fungi mediating P uptake and competitive interactions among species (Smith *et al.* 1999, Hartnett & Wilson 2002). The importance of P to plants is expected to increase as atmospheric N inputs increase, and species dependent on AM fungi for P uptake may be favored, affecting plant diversity and community dynamics. We will test the hypothesis that grassland community structure is co-limited by P (Elser *et al.* 2007) and that P addition decouples above- and belowground linkages, leading to divergent above- and belowground community trajectories. Treatments include P added at 0, 2.5, 5, and 10 g P/m² crossed with N at 0 and 10 g/m² (n=6 per combination). We measure ANPP, plant species composition, and plant-available NO₃⁻, NH₄⁺ and PO₄³⁻ annually; AM fungal colonization is quantified every 2-3 yrs. During LTER VI, we will quantify extraradical mycorrhizal hyphae (Miller *et al.* 1995) and changes in soil microbial community composition (PLFA and NLFA; White & Ringelberg 1998). To date, ANPP has increased in response to added N but not P, except in 2007, and grasses and forbs differ in responses to P additions, with ANPP of the highly mycorrhizal-dependent C₄ grasses negatively impacted by the highest level of P addition. We also see a significant decline in mycorrhizal colonization rates at the highest level of added P, while AM colonization rates increased with N addition. There was no detectable change in plant community composition in response to N or P, though we expect changes to emerge over time (Collins *et al.* 2001). Data from the first five years suggest that these grasslands are not co-limited by N and P, contrary to broader predictions (Elser *et al.* 2007), though this may change with time.

Water × N Experiment (2000-present). The addition of multiple levels of N to the Irrigation Transect Experiment allows us to assess relative N and water limitation, and test for water × N interactions. Understanding how grasslands respond to N additions in combination with water is critical given increases in anthropogenic N deposition and climate change. Our objectives are to (1) determine the relative importance of water and N limitations to ANPP and identify thresholds of response, (2) test for water × N interactions on ecosystem processes, (3) identify differences in responses of plant functional groups and relate these to plant community-level changes, (4) assess responses in soil biota and processes to provide linkages between above- and belowground responses, and (5) determine how these responses vary with topography. Three levels of water (0, 150 and 250 mm/yr in excess of natural rainfall) are combined factorially (n=6) with 4 levels of N (0, 2.5, 5, 10 g/m²) representing a range of N inputs from near ambient deposition rates to those used in other N addition studies. Responses include ANPP, plant N content, and plant species composition measured annually. We also periodically assess selected belowground responses (soil enzymes, soil respiration, decomposition, BNPP (root ingrowth bags), soil fauna, and microbial diversity). We expect strong water × N interactions, with relative responses to water and N contingent on topographic position and natural climatic variability. We also hypothesize that grasses will respond more than forbs to water and N additions, altering plant community composition.

N Press-Pulse Experiment (2006-present). In 2006, we began a second experiment within the Irrigation Transect Experiment to compare responses to ‘pulse’ vs. ‘press’ applications of equivalent amounts of N under high and low water availability. Terrestrial nutrient enrichment studies commonly add nutrients as discrete pulses, though ecosystem may respond differently to chronic resource alterations, as in the case of elevated N deposition. The goals of this experiment are to assess how ecosystem responses (ANPP, soil C and storage) differ with continuous (pressed) vs. pulsed additions of equivalent amounts of N over the growing season. For the press, we add 1 g N m⁻² every 10 days throughout the growing season. The pulse treatment receives an equivalent amount of N in a single event early in the growing season. We are conducting this study in irrigated and non-irrigated sites to assess the extent to which seasonal variability in other resources (*i.e.*, water) may interact with N presses and pulses to

determine ecosystem responses. Preliminary results suggest ANPP responses to pulsed vs. pressed N additions can differ significantly and strongly depend on water availability. This project will be continued in LTER VI to address longer-term responses, with new measurements of belowground responses (root biomass and tissue chemistry, soil microbial biomass, and mineralizable soil C and N pools).

The Nutrient Network Experiment (2007-present). The Nutrient Network (NutNet) was formed in 2007 to assess the extent to which multiple resource limitations and bottom-up vs. top-down controls influence plant community structure and function. NutNet includes >70 investigators and >40 sites across the globe (web.science.oregonstate.edu/~seabloom/nutnet/). At each site, core experiments manipulating N, P and K and herbivores (using exclosures) were established, and data on plant community structure, productivity and soil nutrient availability are being collected using identical methodology. At KNZ, NutNet sites were established adjacent to the *P Addition Experiment* and in an annually burned, bison grazed watershed. During LTER VI, NutNet core data will be collected from these sites and additional site-based studies examining invasion and belowground responses will be initiated.

D4. Aquatic ecosystem responses to environmental change. Kings Creek is the most intensively studied prairie stream on Earth. We will continue monitoring stream discharge and nutrients, groundwater levels and chemistry, and fish community dynamics. Maintenance of these core datasets is an essential contribution of the KNZ program given highly variable prairie groundwater recharge, runoff and nutrient transport (*e.g.*, Dodds *et al.* 1996, Kemp & Dodds 2001), and decadal or greater precipitation cycles coupled with directional climate change. We will initiate new continuous monitoring of O₂ at two sites to establish annual patterns of system metabolism, since point measurements of metabolism do not reveal the complexities of stream ecosystem dynamics (Roberts *et al.* 2007). Annual metabolic data are required to establish autotrophic and heterotrophic state (Dodds 2006). New stream ecosystem research during LTER VI focuses on evaluating the effects of climatic variability, riparian land-cover change and interactive effects of altered trophic structure and nutrient levels. New groundwater research will focus on potential impacts of particulate inputs and elevated CO₂ on weathering and groundwater chemistry.

Riparian woody expansion. Woody expansion is occurring along riparian corridors (see section D1b). Often, shrub encroachment along streams precedes oak gallery forest establishment. Riparian woody encroachment can fundamentally alter terrestrial-aquatic linkages, and change aquatic ecosystem structure and hydrology. Riparian forest expansion alters the timing and type of inputs to streams, and could alter stoichiometry of nutrient cycling in streams, N turnover time in biotic pools (Dodds *et al.* 2004), invertebrate community structure (Stagliano & Whiles 2002), and fish-ecosystem linkages (Bertrand & Gido 2007). To assess the impacts of this land-cover change, and altered linkages between terrestrial and aquatic ecosystems, we will initiate two riparian woody plant removal experiments during LTER VI.

Our first hypothesis is that increased local riparian cover decreases instream autochthonous production, which alters rates of energy flux to consumers. We plan duplicate riparian vegetation removal experiments, at K2A (ungrazed site on the North Branch of Kings Creek with a 2-yr burn frequency) and N4D (4-yr burn frequency, with bison grazing). Treatment reaches will be approximately 50 m long with woody riparian vegetation removal extending ~10 m from each bank. Each site will have intact upstream and downstream riparian canopy and a nearby naturally open grassland reach. This experimental design includes positive and negative controls at each of two sites. We will monitor all reaches each season for stream metabolism (production and respiration), secondary production and abundance of vertebrates and invertebrates, and food web dynamics as assessed by gut contents and stable isotope analyses. Each site will be monitored for two growing seasons before manipulation.

Our second hypothesis is that headwater streams yield less water and retain more nutrients with increased riparian canopy cover. We expect that increased riparian forest cover will reduce stream water flow (as a result of increased transpiration), reduce grasses that retain sediments, and subsidize the stream channels with nutrient-poor/ carbon-rich leaves, leading to greater nutrient retention. We will mechanically remove all woody vegetation within 10 m of either side of a 4-km reach immediately upstream of a weir with a long-term hydrology and water chemistry record (N02B), and will continue to mechanically control woody vegetation for 6 yrs. We have 2 comparison gauged watersheds and 15 yrs

of before-removal water quality data from this watershed. We will continue our standard monitoring regime at this weir to assess the effects of the riparian removal on nutrient and sediment transport.

Interactive effects of trophic structure and nutrient supply on prairie stream ecosystem function. Nutrient pollution increases rates of stream productivity, respiration, and litter breakdown, while decreasing nutrient retention (Niyogi *et al.* 2003, Bernot *et al.* 2006, O'Brien *et al.* 2007). The effects of altered aquatic species or functional diversity can strongly influence ecosystem function and stability (Crowl *et al.* 2001, Vanni 2002, Simon *et al.* 2004, Cardinale *et al.* 2006, Whiles *et al.* 2006, Taylor *et al.* 2006). We will investigate the consequences of simultaneously altering nutrient supply and species composition in prairie streams by quantifying the influence of consumers on ecosystem properties across a gradient of nutrient supply rates. We hypothesize that recovery of autotrophic and heterotrophic components of microbial assemblages following flood and drying will vary with nutrient supply, and their responses will be mediated by the presence of larger organisms (*i.e.*, macroinvertebrates and fish). A pilot experimental stream study, where we simultaneously varied nutrient supply and density of a grazing fish species, provided preliminary support for this hypothesis. For LTER VI, we will expand this experiment to test the effects of other common functional groups of stream organism, and to develop field experiments to qualify these results. Our main response variables will be stream metabolism and nutrient retention, because they are central to ecosystem function and related to water quality. These experiments will test the mechanistic effects of subsets of the consumer assemblages in Konza streams, and test theories of links between functional diversity and ecosystem structure (Cardinale *et al.* 2006). In theory, grazers should have the strongest negative effect on primary production at high nutrient supply because their effect on nutrient mineralization is inconsequential. With no top-down effect, water-column omnivores should increase primary production particularly at low nutrient supply. Nutrient supply and trophic structure of stream reaches can be accurately predicted by reach across watersheds using existing geographic information system (GIS) data, so our results can be extrapolated to entire watersheds.

Patterns and controls of fish community structure. Tracking long-term dynamics of fish communities in Kings Creek has facilitated a broader conceptual understanding of prairie streams (Dodds *et al.* 2004). Seasonal electrofishing surveys on Kings Creek (since 1995) characterize fish community dynamics in response to flood, drying, and watershed position (Franssen *et al.* 2006). Sample locations in headwater reaches are isolated from permanently flowing downstream reaches by ~5 km of intermittent stream, allowing us to quantify population dynamics (extirpations and colonization) in headwaters as a function of intra- and inter-annual climate variability. Drought increases the probability of extirpation and floods are necessary for recolonization from downstream (Franssen *et al.* 2006); LTER data will allow us to test the importance of time lags in regulating fish population dynamics. We will also measure lengths of all fish captured to evaluate effects of isolation on growth rates of each species. We recently established sites in three headwater tributaries and a downstream reach in the Fox Creek watershed 60 km to the south on the Tallgrass Prairie Preserve near Cottonwood Falls, KS. Expanding our sampling to these comparable Flint Hills streams will provide a regional assessment of prairie stream fish assemblage dynamics.

Groundwater chemistry and hydrology. Observations over 17 yrs have documented annual cycles of water-chemistry and level variation in wells up to 12 m deep and in nearby streams; LTER V modeling and assessment showed that major dissolved components (alkalinity, Ca, Mg) have increased. Groundwater level measurements show high annual variability in recharge periods, rapid response of groundwater level, temperature and streamflow to recharge events, and diel fluctuations driven by plants during the growing-season (Kissing & Macpherson 2006). Calculated and measured groundwater CO₂ is increasing and pH is decreasing over decades, driving increased chemical weathering (Macpherson *et al. in review*). We will continue to assess the rate of change in groundwater CO₂ during LTER VI. Mineral weathering supplies groundwater with dissolved constituents and > half the mass of weathered solids appears to originate from allochthonous aerosols (Wood & Macpherson 2005). Aerosol inputs (Derry & Chadwick 2007, Simonson, 1995) may impact nutrient budgets (Swap *et al.* 1992, Chadwick *et al.* 1999) and buffer chemical weathering of landscapes. Chemical weathering rates and dust-flux estimates (Smith *et al.* 1970) are both ~600 kg ha⁻¹ y⁻¹. We will establish 8 replicate passive aerosol collectors in likely high-dust locations (concave, windward slopes and on slopes parallel to wind direction; Goossens 2000, 2007). We will characterize nutrient content of aerosols and trace weathering from soils and aerosols

(Mason & Jacobs 1998). We expect chemical differences between local or far-traveled dust and the Pleistocene loess-derived soils of Konza (Muhs 2001, Macpherson *et al.* 2005, Holmes & Miller 2004, Derry & Chadwick 2007). Isotopes do not clearly differentiate aerosols on continental scales (Grosset & Biscaye, 2005), but can identify local sources (Aleinikoff *et al.* 1999). We will add targeted collections for isotopic analyses ($\delta^{13}\text{C}$, $\delta^{18}\text{O}$, and δD) to support mass-balance modeling for water-path differentiation (Hendry & Wassenaar 2004) and to link with studies of soil water uptake by plants (Nippert & Knapp 2007b).

D5. Regionalization, remote sensing, and modeling. Data from the KNZ program will continue to support regionalization and modeling activities relevant to the surrounding Flint Hills (Fig. 29). Ecological structure and function in this region are strongly influenced by (1) complex geomorphology, (2) a variable and changing continental climate, and (3) patterns of human settlement and land/water use. Humans are altering historic ecological drivers, and adopting novel land uses including alternative grazing systems, suburban and exurban development, and most recently increased biofuel production and development of large-scale wind farms. Here we describe our use of remote sensing and LTER data to support studies assessing the impacts of anthropogenic changes on a regional scale.

Remote sensing studies. We will expand the spatial extent of our studies beyond the boundaries of Konza by collecting and analyzing multirate (6-10 times per growing season) airborne multispectral sub-meter resolution digital imagery (Fig. 29) from surrounding grasslands. We will characterize and compare phenological dynamics of different plant life-forms (C_3 woody plants and C_4 grasses) and the biophysical responses of these plants to ecological factors driving community dynamics. Biophysical and biochemical response patterns will allow us to extrapolate to the regional scale, using multiple remote sensing datasets (30-m Landsat TM data, NDVI computed from 250-m Moderate Resolution Imaging Spectrometer (MODIS) composited on a 16 day basis from 2000-present, and 1-km spatial resolution Advanced Very High Resolution Radiometer (AVHRR) composited on a weekly basis from 1989-present). Annual and interannual NDVI patterns associated with ecosystem response to climate, land management and fire regimes will be linked to changes in plant community composition (Price *et al.* 2004).

A multi-model approach for predicting effects of multiple stressors on Flint Hills' ecosystems. We are collaborating with scientists from the EPA, Marine Biological Laboratory, and Georgia Tech University to develop spatially-explicit databases and models to assess effects of interacting stressors on Flint Hills' grasslands. Our goal is to develop a comprehensive "ecosystem simulator" to assess the cumulative spatial and temporal effects of fire, grazing, invasion of woody species, climate change, and contaminants in this region. We are developing linked, spatially-explicit models that mechanistically simulate long-term changes in ecosystem dynamics as a result of natural and anthropogenic stressors. The models include a biogeochemistry/plant community model (MEL; Rastetter *et al.* 1992) linked to a hydrology model (TOPMODEL; Stieglitz *et al.* 1997, 2004) to predict fate and effects of water, nutrients and contaminants in terrestrial ecosystems and associated surface waters. Resulting changes in water and nutrient cycles influence plant species composition, which in turn influences habitat structure and quality, which feeds into a spatially-explicit population model (PATCH; Schumaker *et al.* 2004). Model results will provide integrated assessments of stream discharge and water quality, terrestrial biogeochemistry, plant productivity and habitat structure, and wildlife population dynamics. By providing data on spatial and temporal patterns of biomass production, model output can also provide input to regional fire and air quality models.

BlueSky/RAINS system for managing prescribed fires and protecting air quality. Prescribed fire is a crucial regional management tool. However, smoke from prescribed fires impacts regional air quality, especially in urban areas where chemical reactions with other pollutants increase ozone. In spring 2003, multiple concurrent fires in the Flint Hills pushed ozone concentrations over the 8-hr EPA standard for Kansas City. EPA and Kansas agencies are now developing procedures to coordinate regional grassland burning, and KSU researchers are modifying the USDA Forest Service BlueSky/RAINS model, a web-based smoke forecasting system, for use in grasslands. Research at Konza on fine fuel loads, fire characteristics, emissions, and near-field plume dynamics will provide data for model parameterization.

Assessing environmental drivers of host ecology and disease emergence. Emerging diseases are linked to ecological patterns (NAS 2000). As part of LTER VI, we will develop a spatially and temporally explicit, individual-based model of landscape epizootiology to examine how ecological patterns of resource distribution, habitat alteration, and physical barriers shape the epizootiological processes of rabies. Our primary goal is to predict changing public health risk and the effect of disease intervention methods. To develop and parameterize our model, we will examine endogenous and exogenous mechanisms of transmission of rabies in its host species, the striped skunk (*Mephitis mephitis*), using data collected from free-ranging animals at Konza. We will measure both host- and viral-specific properties of transmission to develop a predictive model of transmission based on stochastic contact networks. We will combine animal movement and landscape genetic data to characterize habitat use, demography, and connectivity of striped skunks in a matrix of habitats, and couple with similar measurements in other land-uses off-site (e.g., suburban Manhattan, KS). Landsat imagery will be analyzed to identify and model the changing geography of skunk habitat and associated rabies risk, and a cellular automata approach will be used to model-disease specific LULCC. This landscape-level understanding of host species' responses to LULCC is critical for predicting how disease transmission and epizootiology are altered by global change.

Social science / regional context for the Konza LTER program. During LTER V, the Konza social science group provided context for the social and environmental dynamics in the region (Middendorf *et al. in review*). A regional environmental history established baseline information on changing human occupancy and land use. We also completed an inventory of ecosystem services for the Northern Flint Hills and initiated interviews of local stakeholders for information sources and rationale driving LULCC. During LTER VI, we will increase efforts to document regional LULCC and assess both the direct and indirect drivers of change. For example, we will update and improve the spatial resolution of studies linking regional woody encroachment and human population dynamics (Hoch *et al.* 2002) using new satellite data and census block groups or census tracts. We will also identify social factors contributing to changes in land management and/or land cover conversion using interviews of land owners and managers, and expand our assessment of ecosystem services for the Flint Hills.

E. Synthesis. The maturation of the KNZ program and the LTER network provides new opportunities for synthesis and integration at the site-, biome- and network levels. Synthetic analyses may derive from a long-term dataset or study at one site (Nippert *et al.* 2006, Jonas & Joern 2007), a suite of studies at one site (Blair *et al.* 2000, Dodds *et al.* 2004, Briggs *et al.* 2005), or similar studies or datasets across sites (Chalcraft *et al.* 2004, Knapp *et al.* 2008). The KNZ program has a strong history of both site-based synthesis, and of contributing to broader syntheses (e.g., initiatives sponsored by the LTER Network Office or the National Center for Ecological Analysis and Synthesis; Adler *et al.* 2005, White *et al.* 2006, Grace *et al.* 2007, Heatherly *et al.* 2007, Knapp *et al.* 2008, and others). We provided many examples of such cross-site and cross-biome research in the *Prior Results* section, and we will continue to address ecological questions that span multiple LTER and non-LTER sites. For example, we will continue international cross-site studies with collaborators in South Africa and Botswana to address the generality of ecological rules derived from KNZ research to grasslands in other parts of the world. Many other cross-site research projects are underway or planned for LTER VI and the establishment of a formal *Synthesis Group* as part of the KNZ program is emblematic of our commitment of time and resources to this goal.

Integration and synthesis at the site level will be promoted by the theme-based organization of our research program, where interdisciplinary research groups address multiple facets of complex ecological questions, across multiple spatial and temporal scales and levels of biological organization. Interactions among research teams will be promoted by monthly meetings of local researchers, and by an annual Konza Prairie All Scientist LTER meeting that focuses on the seven major research areas for LTER VI (p. C-7), with an outside keynote speaker invited to present fresh perspectives on the theme for that year. In addition, it has been 10 yrs since the publication of our most ambitious site-based synthetic effort to date – “*Grassland Dynamics, Long-Term Ecological Research in Tallgrass Prairie*” (Knapp *et al.* 1998). Much new information has been generated since, particularly in the area of grassland responses to global change. We will host a symposium on *Grasslands and Global Change*, with invited national and international speakers and KNZ scientists providing synthetic talks on the state of knowledge with respect to understanding and forecasting grassland responses to change. An edited volume is the planned product.

Fig. 1. (Right) Cumulative number of publications resulting from Konza Prairie LTER research during the past five LTER funding cycles.

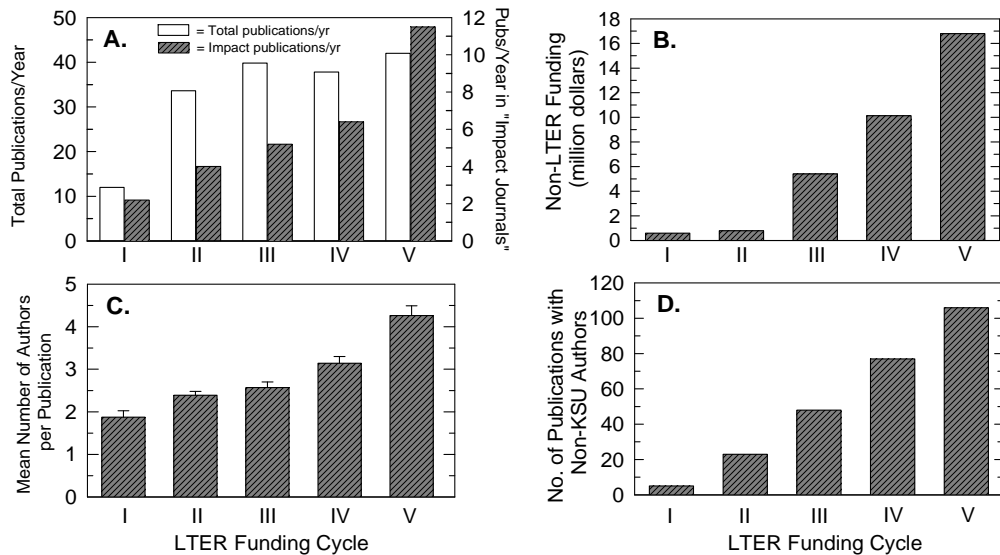
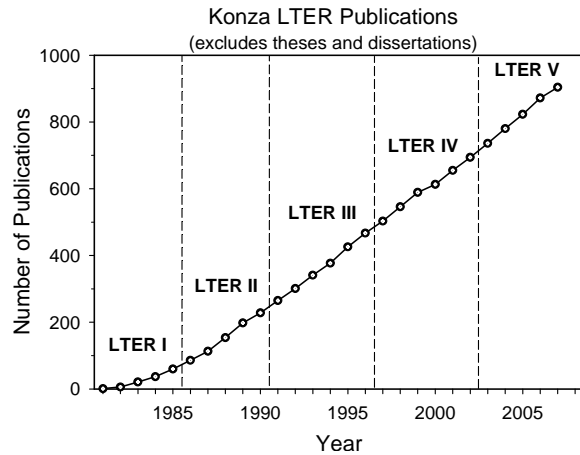

Fig. 2. **A:** Mean Konza LTER publications/yr (excluding theses and dissertations) in each of the prior funding cycles (*open bars*). The number of publications/yr in “impact journals” (i.e., *Science*, *Nature*, *PNAS*, *Ecology*, *Ecological Applications*, *Journal of Ecology*, *Journal of Applied Ecology*, *American Naturalist*, *Oecologia*, *BioScience*, *Oikos*) is also indicated (*filled bars*). **B:** Trends in extramural research dollars generated, in addition to LTER funds, during each of the prior LTER funding cycles. **C:** Trends in the mean (\pm SE) number of authors per publication for each of the LTER funding cycles. **D:** Numbers of Konza LTER publications per funding cycle led by or including non-KSU authors.

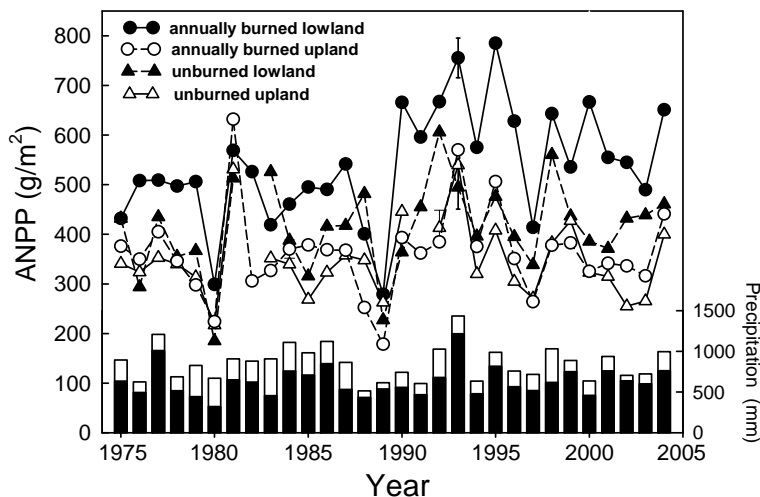

Fig. 3. Konza LTER data on ANPP and precipitation reveal high interannual variability and the importance of long-term data for assessing responses to fire or other disturbances. Data are from permanent sampling transects at lowland (circles) and upland (triangles) topographic positions on watersheds burned annually (solid symbols) or every 20 yrs (open symbols). Across topographic positions and years, annual fire increases ANPP by increasing productivity of the dominant C_4 grasses, while decreasing productivity of the species-rich forbs (see Fig. 4).

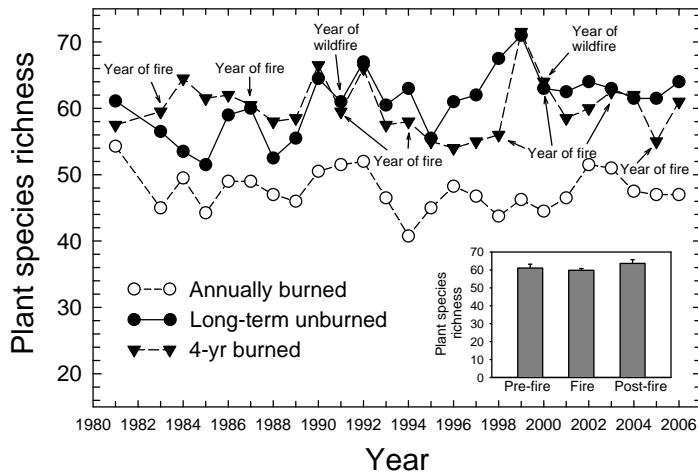

Fig. 4. LTER data reveal that annual fires reduce species richness relative to less frequent fires. *Inset:* Plant species richness does not respond to individual fires; thus, long-term consequences of different fire regimes cannot be predicted based on short-term responses to individual fires. Collectively, these data demonstrate the importance of long-term studies for understanding patterns and controls of ecological processes in tallgrass prairie.

Fig. 5. Change in cover of woody plant species 4 yrs after a switch in long-term fire regimes (the 'Fire Reversal Experiment.'). *Left panels:* Data from now unburned watersheds that were burned annually until 2001. *Right panels:* Data from previously unburned watersheds that have been burned annually starting in 2001. *Top panels* are total area of dominant shrub species. *Bottom panels* are mean size of shrub patches. *Inset* is the total number of shrub patches. Note the order of magnitude difference in pre-reversal woody plant cover and number of patches.

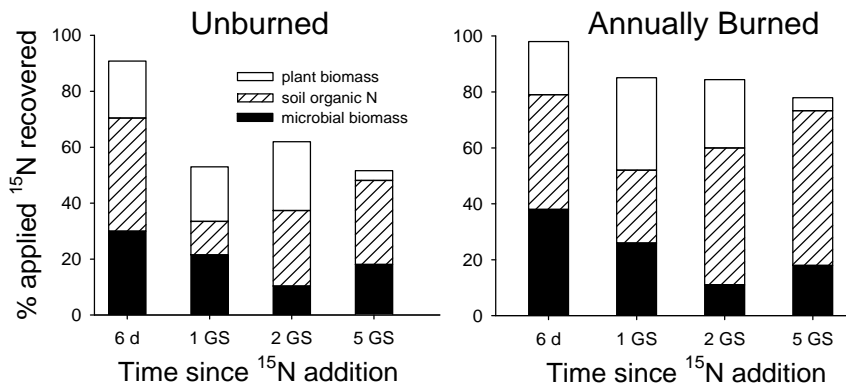
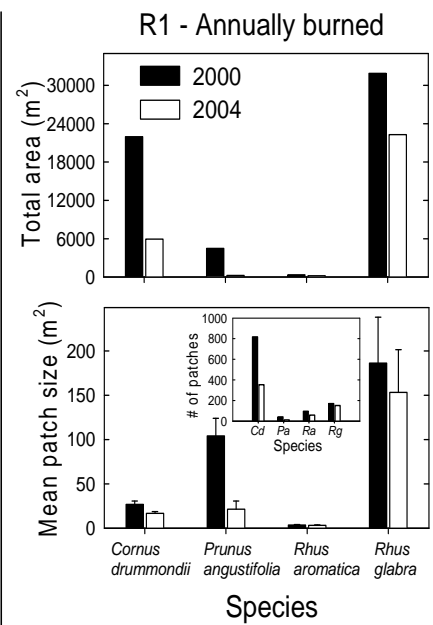
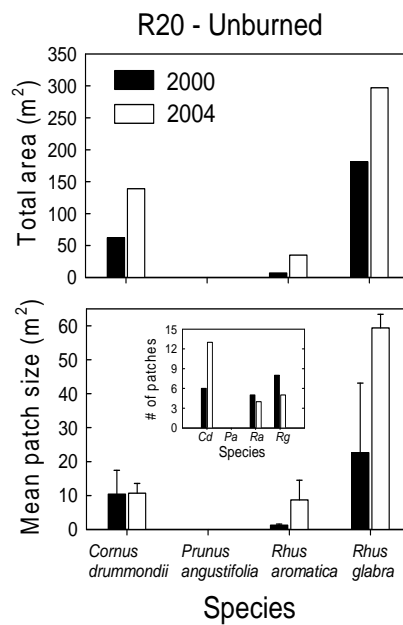

Fig.6. Konza LTER studies have demonstrated that frequent burning lowers soil N availability and increases N limitation to plants (Blair 1997). In a 5-yr study, Dell *et al.* (2005) followed a pulse of added ^{15}N , and found that a greater percentage of the ^{15}N was retained in annually burned prairie. The majority of recovered ^{15}N was immobilized in soil organic N and microbial biomass N pools by the end of the fifth growing season (d= days; GS= growing seasons).

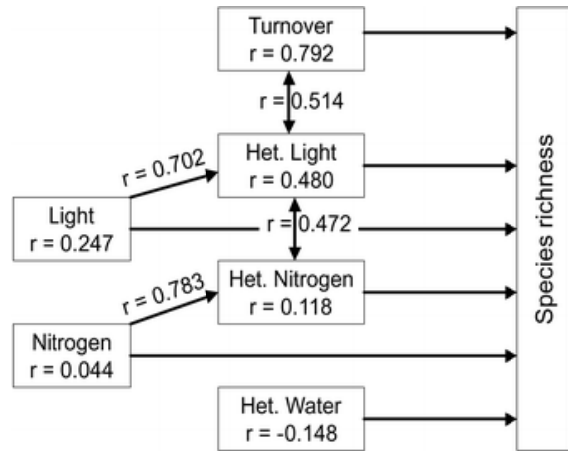

Fig. 7. *Left:* Bison grazing at Konza Prairie. *Right:* Diagrammatic representation of the path analysis of the importance of resource amount and heterogeneity (Het.) and species turnover as influences on species richness in a mesic grassland. All correlations of species richness with potential mechanisms affecting this parameter are shown in the boxes and correlations between mechanisms are shown across arrows. Correlations are only included when significant and ecologically meaningful. From Bakker *et al.* 2002.

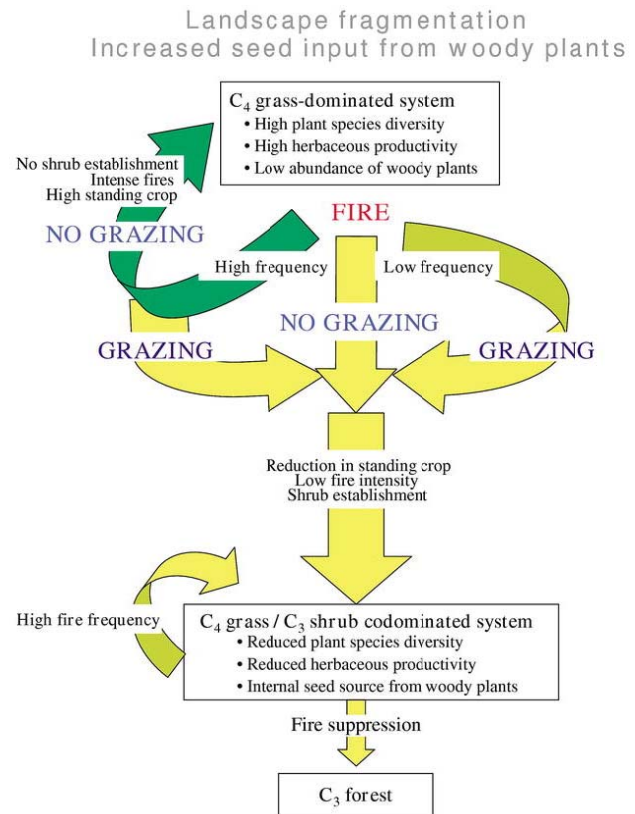

Fig 8. *Top photo:* A Konza Prairie watershed that has been burned annually in the spring for more than 20 years. Note the dominance of C₄ grasses and lack of woody vegetation. *Bottom photo:* A watershed at Konza that has been burned in spring every 4 years since 1971. Note the abundance of woody vegetation, particularly the shrub *Cornus drummondii*. *Right:* Flowchart illustrating the hypothesized primary pathways by which native tallgrass prairie may be converted to a grass-shrub co-dominated system, or eventually to forest, under the chronic pressures of landscape fragmentation and increased propagule pressure as seed input from woody plants increases with regional land-cover change.

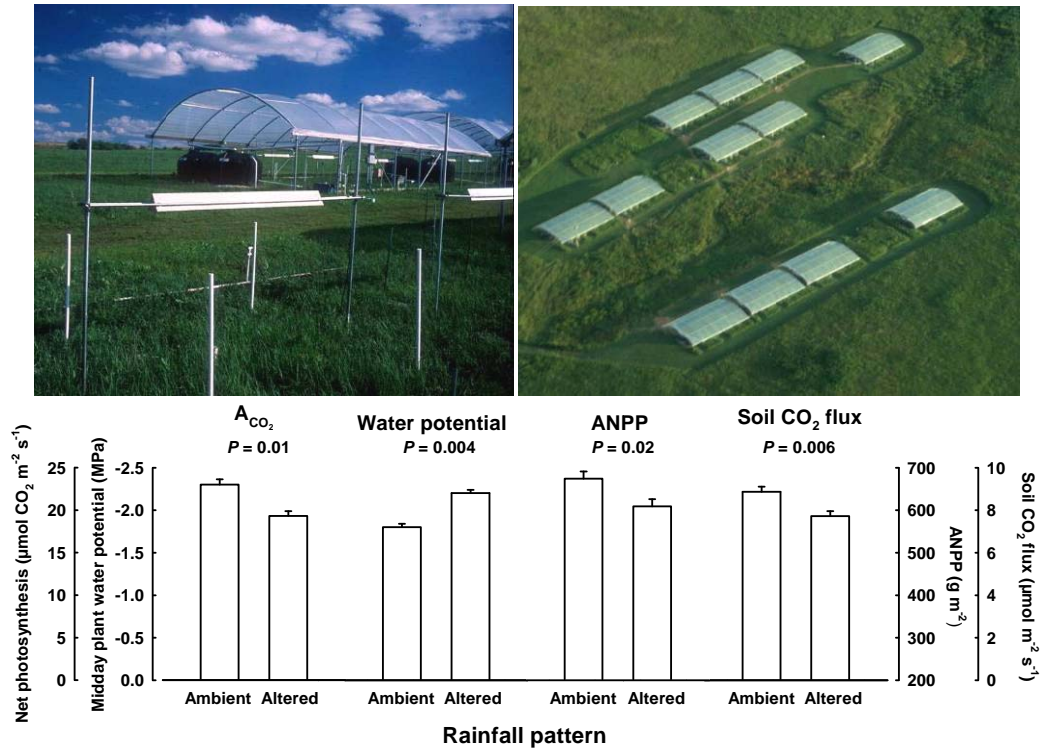

Fig. 9. *Top:* Ground-level and aerial view of Rainfall Manipulation Plots (RaMPs) at Konza. The shelters exclude natural rainfall, and allow manipulation of rainfall timing and temperature in intact prairie plots. Treatments include more extreme rainfall timing and elevated temperature. *Bottom:* Responses in three key C cycling processes to altered vs. ambient rainfall patterns. These include: midday net photosynthesis (A_{CO_2}) by *A. gerardii*, shown with an estimate of mid-summer plant water stress (water potential); aboveground net primary production (ANPP, an integrator of net C uptake by all species); and seasonal mean soil CO_2 flux, an indicator of belowground plant and microbial respiration. From Knapp *et al.* 2002.

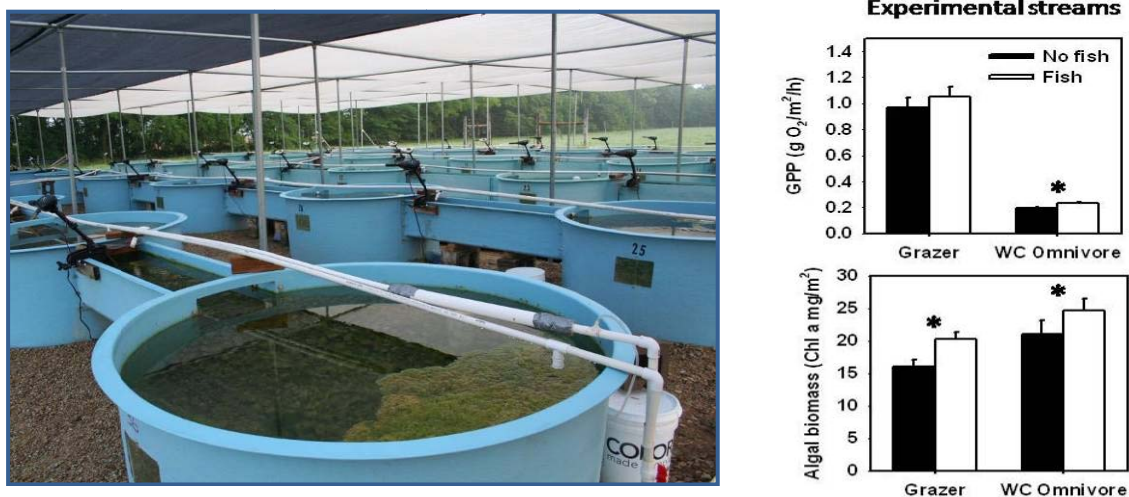

Fig. 10. *Left:* Konza experimental stream facility. There are 36 single separate recirculating pool-riffle units that mimic nearby natural stream pool sizes and riffle depths as well as hyporheic subsurface area A_s/A . *Right:* Contrasted effects of grazers and water-column minnows on gross primary productivity (GPP) and algal biomass across multiple experiments in this facility (asterisks indicate significant effects of consumers). In general, fishes stimulated biomass and GPP in experimental streams, which we hypothesize is due to increased nutrient recycling in the presence of consumers. From Bertrand 2007.

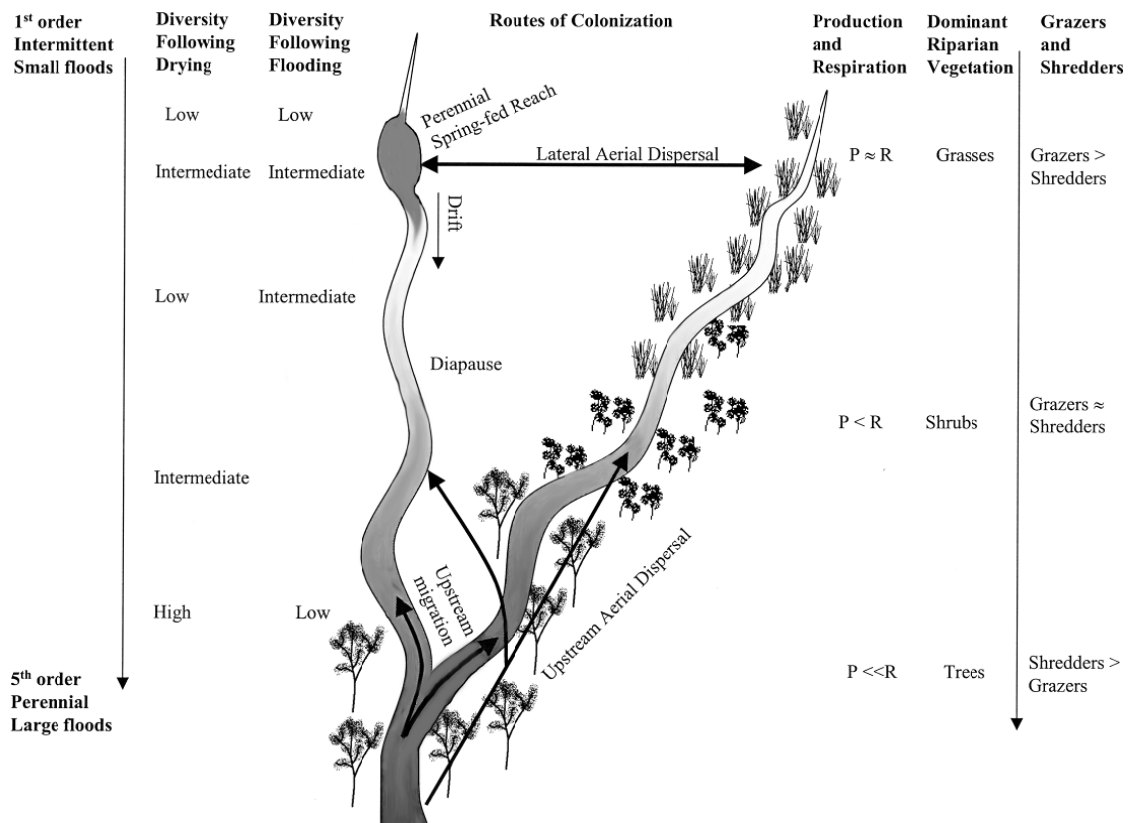

Fig. 11. Conceptual model of the prairie stream continuum (Dodds *et al.* 2004). This is a highly variable system characterized by intermittent flows with periods of drying punctuated by flooding. From upstream to downstream the probability of drying decreases while the intensity of flooding increases. Lack of upstream riparian canopy allows for substantial autochthonous production, and leads to food webs with little dependence upon leaf in-fall. Drift from upstream spring pools and upstream migration are the dominant modes of recolonization by stream fauna.

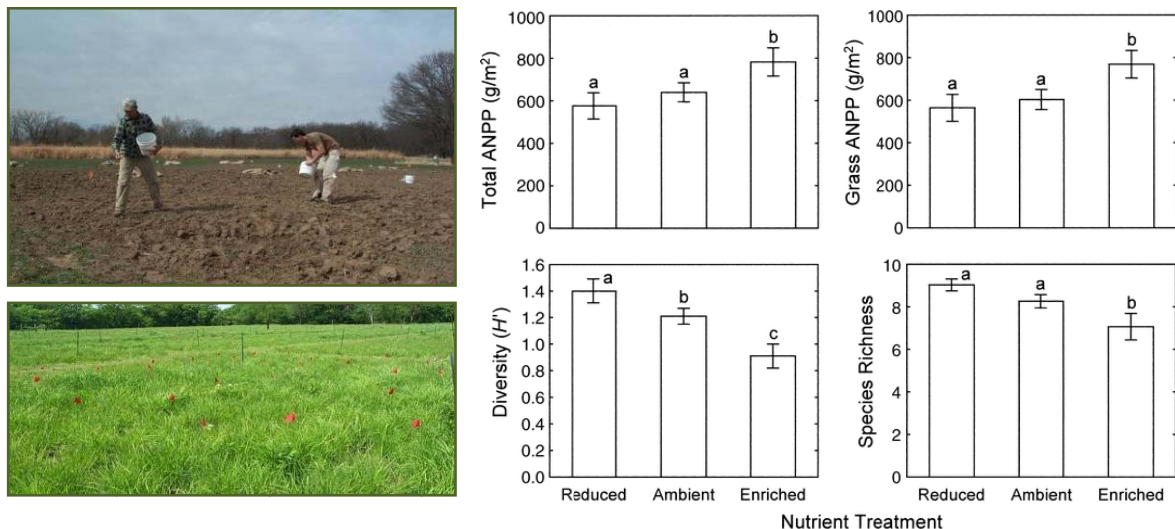
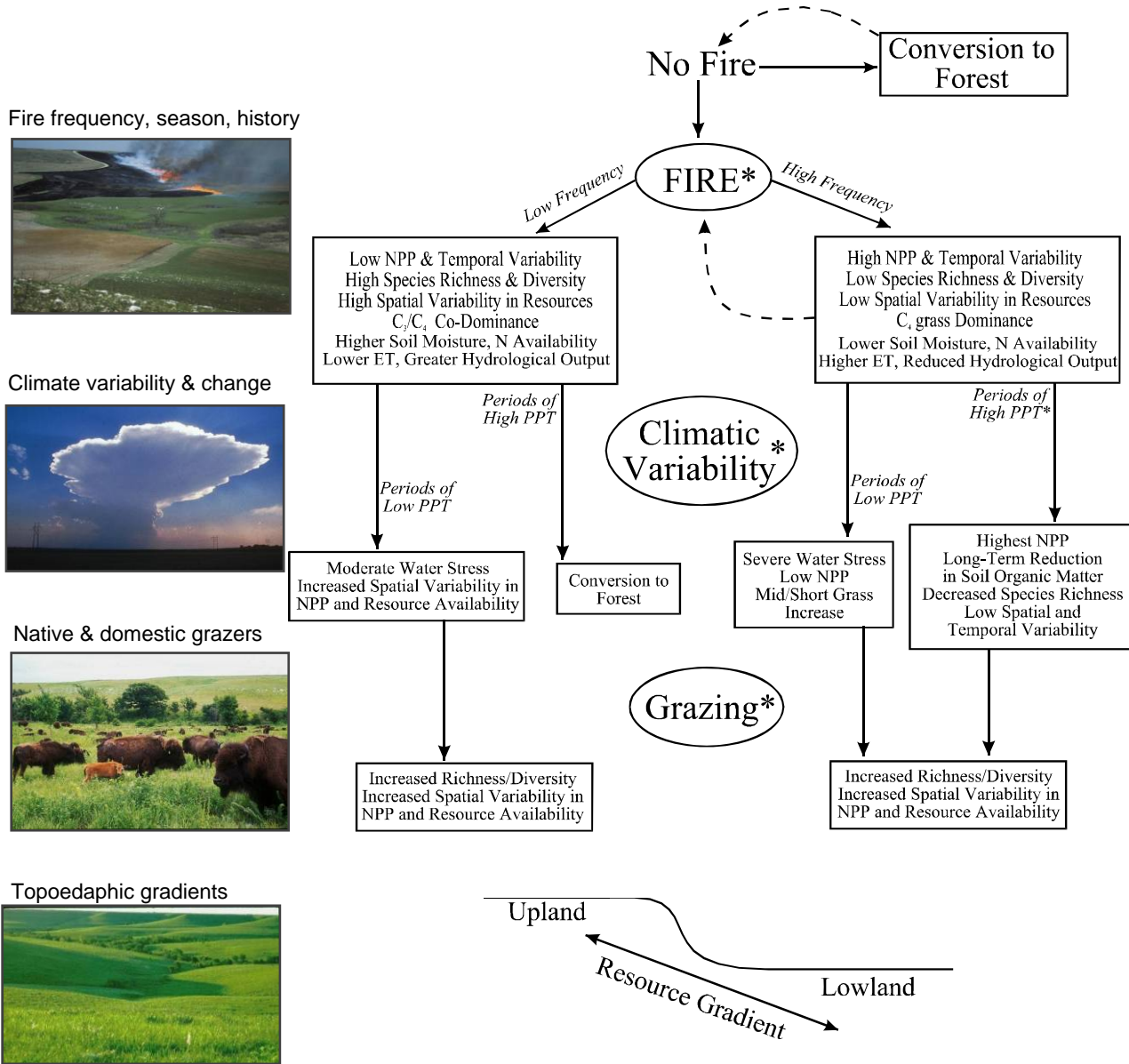

Fig. 12. *Left:* Initiating a prairie restoration at Konza (top) and plots in a field restored in 1998 (bottom). *Right:* Plant responses to multiple levels of available N and soil depth are being assessed in a long-term restoration experiment at Konza. Shown above are main effects of the nutrient treatments only, including mean (± 1 SE) ANPP of the total community and of the dominant C₄ grasses, plant diversity (Shannon's index, H'), and plant species richness (# species/0.25 m²). N enrichment increased ANPP (total and grass) and reduced plant species diversity and richness (Baer *et al.* 2003).



* denotes experimental manipulations as part of LTER

Fig. 13. Conceptual model highlighting the importance of fire, climatic variability and grazing across topographic gradients at Konza Prairie (Knapp *et al.* 1998). These three factors influence organismic through ecosystem processes independently and interactively, with responses also dependent on topoedaphic patterns of resource availability. All of the proposed responses shown in boxes are being evaluated with long-term watershed- and plot-scale experiments as part of the Konza LTER program.

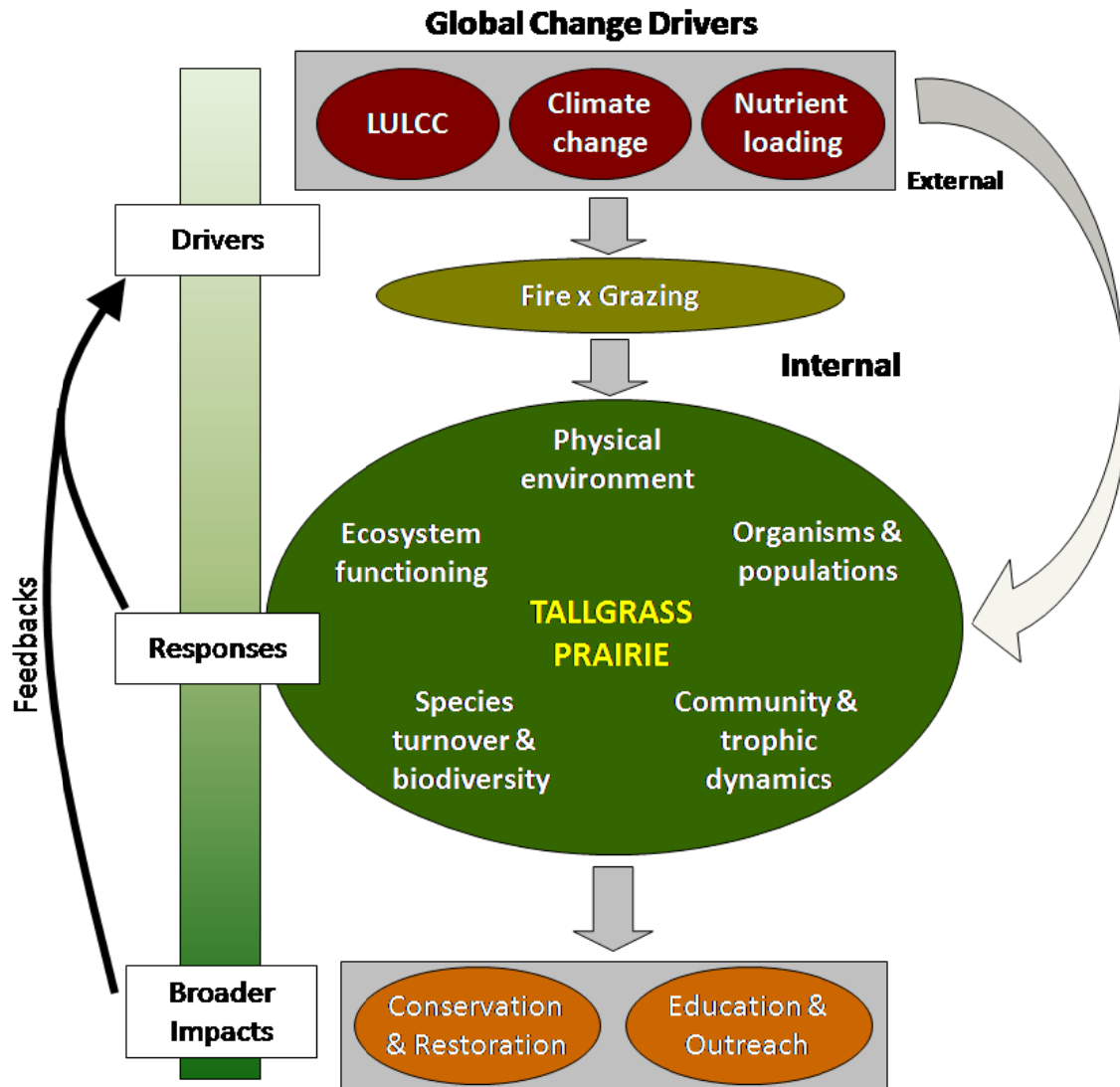

Fig. 14. Conceptual framework for LTER VI. The regionally important components of global change addressed by LTER VI include: land-use and land-cover change (LULCC), climate change, and nutrient enrichment. In this model, drivers are divided into external (regional) and internal (local) categories. External drivers include changes in regional climate patterns, changes in habitat fragmentation and species pools due to regional LULCC, and elevated nutrient inputs occurring throughout the Central Plains. External global change drivers can directly affect ecological communities and processes in grasslands, and can interact strongly with critical internal drivers, such as fire and the activities of large grazers, to influence tallgrass prairie structure and function at all levels. These internal changes in ecological structure and function can, in turn, result in further changes in ecological states (specific internal feedbacks and processes are omitted for simplicity). We will investigate relationships between external and internal ecological drivers and grassland responses encompassing the abiotic environment and organismic-to-ecosystem levels. We also recognize the importance of inherent feedbacks between ecological processes and drivers, and feedbacks related to socio-ecological outcomes (left column). Thus, changes in ecological processes in grasslands not only feedback to influence internal drivers (*e.g.*, fire regimes and grazing) and external drivers (*e.g.*, future trajectories and rates of climate or land-cover change, atmospheric nutrient inputs), but ultimately they can lead to broader impacts through socio-ecological interactions, such as when public education and outreach influence adoption of conservation and restoration strategies.

Fig. 15. *Right:* Historic distribution of tallgrass, mixed-grass and shortgrass prairie in North America. The 50,000-km² Flint Hills includes the largest remaining areas of native tallgrass prairie. *Below:* Konza lies at the ecotone between deciduous forest and more arid grasslands. Two important gradients influence grasslands in this region: a north-south temperature gradient, which is correlated with C₃-C₄ plant species composition, and a west-east precipitation gradient that affects species distributions, as well as regional patterns of ANPP, decomposition, N availability and soil C storage.

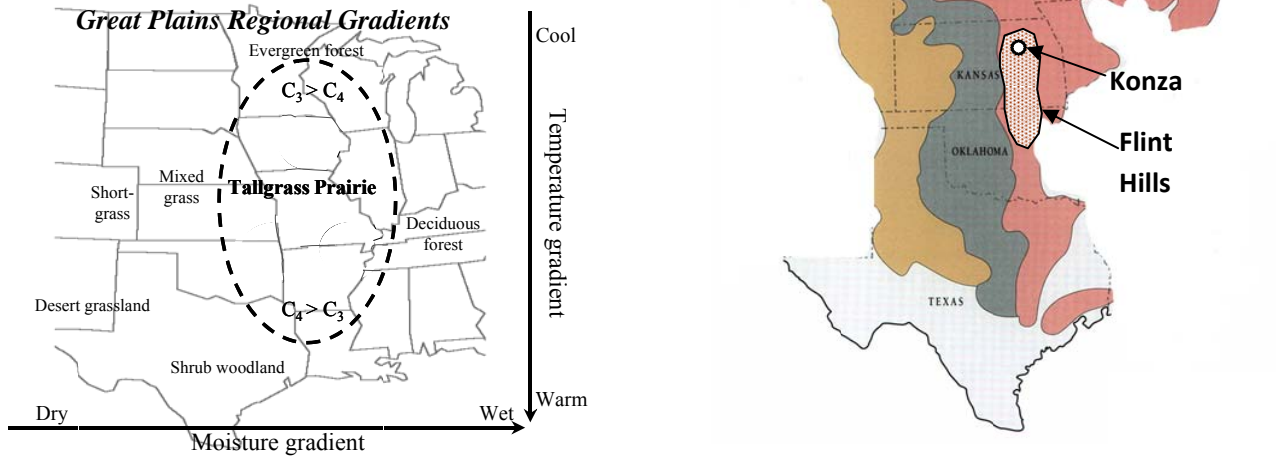

Fig. 16. The Hierarchical Ecosystem Response (HER) model depicts a potential hierarchy of mechanisms underlying non-linear ecological change (*thick black line*) in response to chronic (“press”) resource alterations, such as those driven by global change. Relatively modest initial ecosystem responses reflect relatively rapid physiological responses (A), with the magnitude and extent of this initial response limited by traits of the resident species. Larger shifts in ecosystem response/state are expected with re-ordering of species (B) in the community (*e.g.*, shifts in relative abundance). The timing and duration of this phase may vary depending on the rate of population turnover, or may be attenuated depending on internal interactions. Finally, immigration of new species better suited for altered resource levels may result in further change in ecosystem response/state (C). Timing may depend on the regional species pool and dispersal limitation. Other responses to chronically altered resources are possible, including gradual linear change (*thin grey line*) if the magnitude and rate of change were similar for all three mechanisms (A, B, and C). Potential exceptions may include ecosystems dominated by long-lived species with slow turnover rates (D), or ecosystems susceptible to invasion as a result of resource alterations, which may bypass state changes (E).

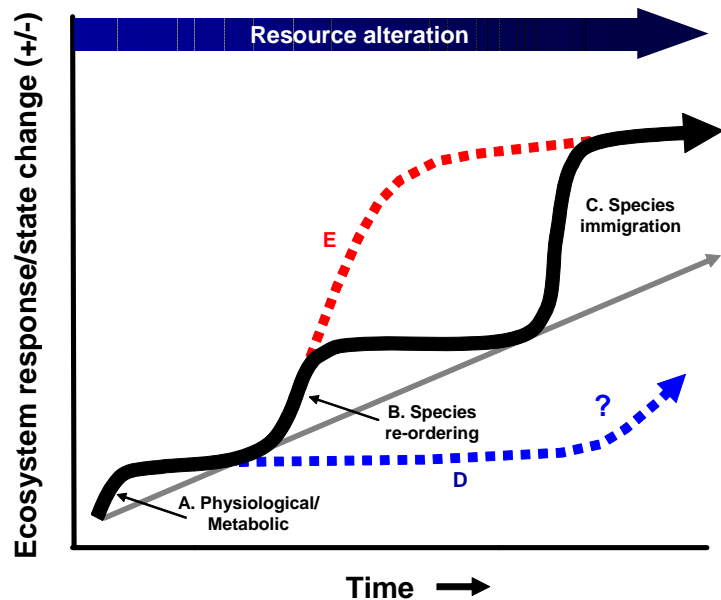

Fig. 17. Konza Prairie site experimental design, and watershed-level fire and grazing treatments. Watersheds with native ungulate (bison) grazing ('N') are highlighted in light green, and cattle-grazed watersheds ('C') are dark green. The new patch-mosaic grazing study will include the Shane Creek watersheds ('S', light purple). All other watersheds except WP and THP are ungrazed. Numbers in watershed codes designate fire return intervals for spring-burned watersheds, and the last letter of watershed codes (A,B,C,D) identifies replicate watersheds of the same treatment. Watersheds subject to different seasons of burn (W=winter, F= fall, Sp= spring, SU=summer) are highlighted in brown, and the Fire Treatment Reversal ('R') watersheds are highlighted in yellow. Many KNZ plot-level experiments (Belowground Experimental Plots, RaMPs, Irrigation Transects) are located at the headquarters areas (HQ) in the northwest portion of the site. Additional details on the experimental design and treatments are provided in the text.

KONZA PRAIRIE BIOLOGICAL STATION EXPERIMENTAL DESIGN

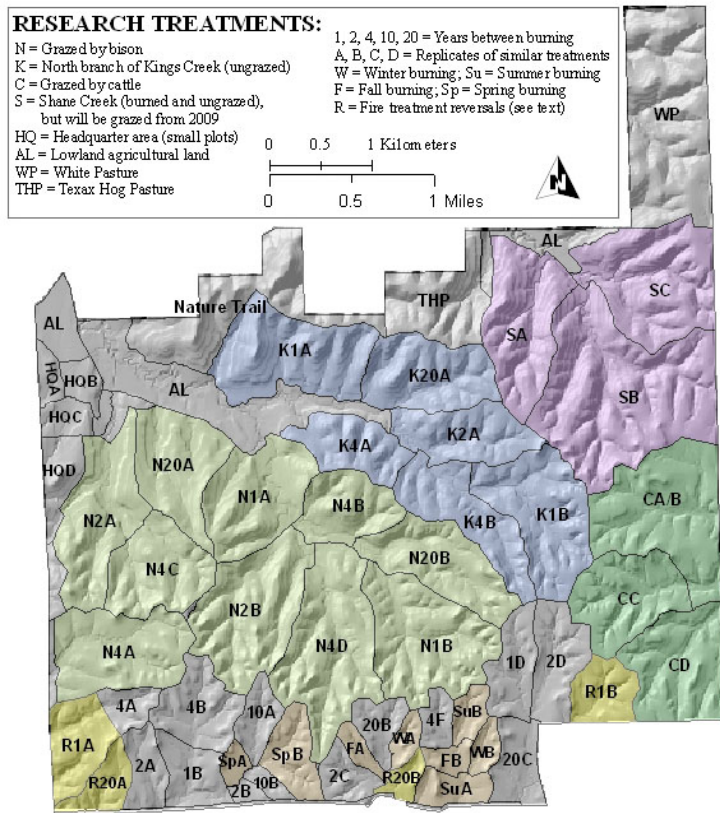

Table 1. Selected long-term plot experiments of the Konza LTER program. Such experiments complement our long-term watershed-scale studies, and provide important information about mechanisms underlying responses at broader scales. These experiments are also focal points for ecological studies that span multiple disciplines. Additional ongoing and new plot experiments are listed in the Project Description.

Experiment (year begun)	Treatments	Main Response Variables
Belowground Plot Experiment (1986)	Combinations of burning, mowing and nutrient (N, P) additions	ANPP, BNPP, plant species composition, plant N and P content, decomposition, soil chemistry, soil biota
Rainfall Manipulation Plots (RaMPs) (1997)	Timing and amount of ppt; increased temperature; simulated grazing (new)	ANPP, BNPP, plant species composition, plant ecophysiology, decomposition, soil C and N pools & fluxes, soil biota
Irrigation Transect (1991)	Growing season water additions, upland and lowlands; new N treatment added in 1999	ANPP, plant species composition, plant N content, BNPP, decomposition, soil C and N flux, soil biota
P Addition Experiment (2002)	P added at 4 rates, +/- N to assess relative N and P limitation	ANPP, species composition, mycorrhizal colonization levels, soil N and P fractions
Prairie Restoration & Heterogeneity Experiment (1998)	Soil depth and N availability manipulated to alter resource availability and heterogeneity	ANPP, species composition, root biomass, plant tissue chemistry, soil C/N pools and fluxes

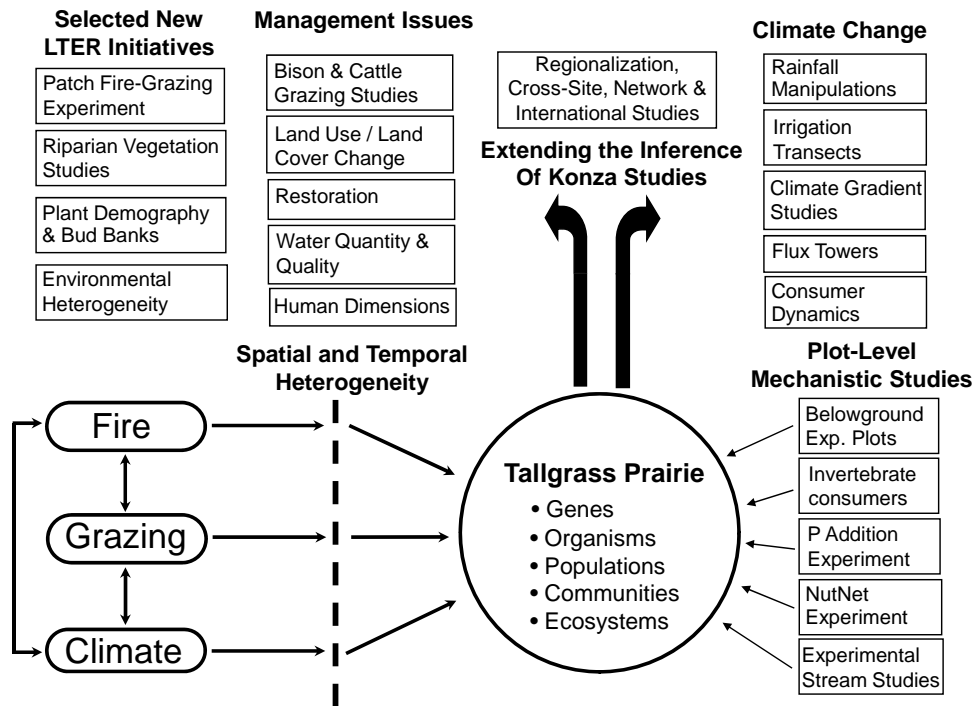

Fig. 18. Integration of ongoing and new KNZ LTER research. Core LTER experiments focus on how fire, grazing and climatic variability across a spatially heterogeneous landscape produce ecological responses and temporal variability at organismic to ecosystem levels. These long-term studies have given rise to new watershed-scale studies, and complementary plot-level experiments that provide insights into mechanisms underlying biotic responses. New LTER VI studies that address changes in climate and land use/land cover relate directly to our global change theme, and are integral to regionalizing KNZ results.

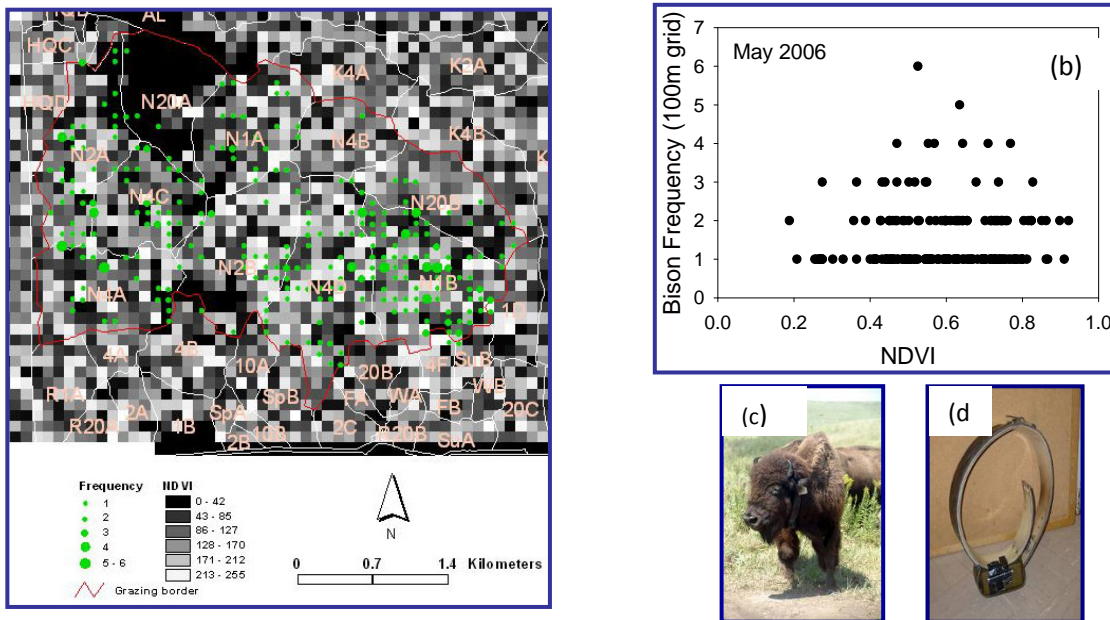

Fig. 19. (a) Frequency distribution (100m resolution) of the location of one GPS-collared bison (W630) in May 2006 across the Konza Prairie landscape. Vegetation (NDVI at 100m from remotely sensed ASTER spectral data, index multiplied by 255) is also mapped here (b) Landscape position of W630 related to NDVI during May 2006, indicating preference for areas with intermediate NDVI values. (c) Adult female bison (W630) with Telonics GPS collar. (d) Close-up of collar. A total of 10 bison have been fitted with GPS collars for LTER VI research on patterns of grazer activity in relationship to landscape heterogeneity.

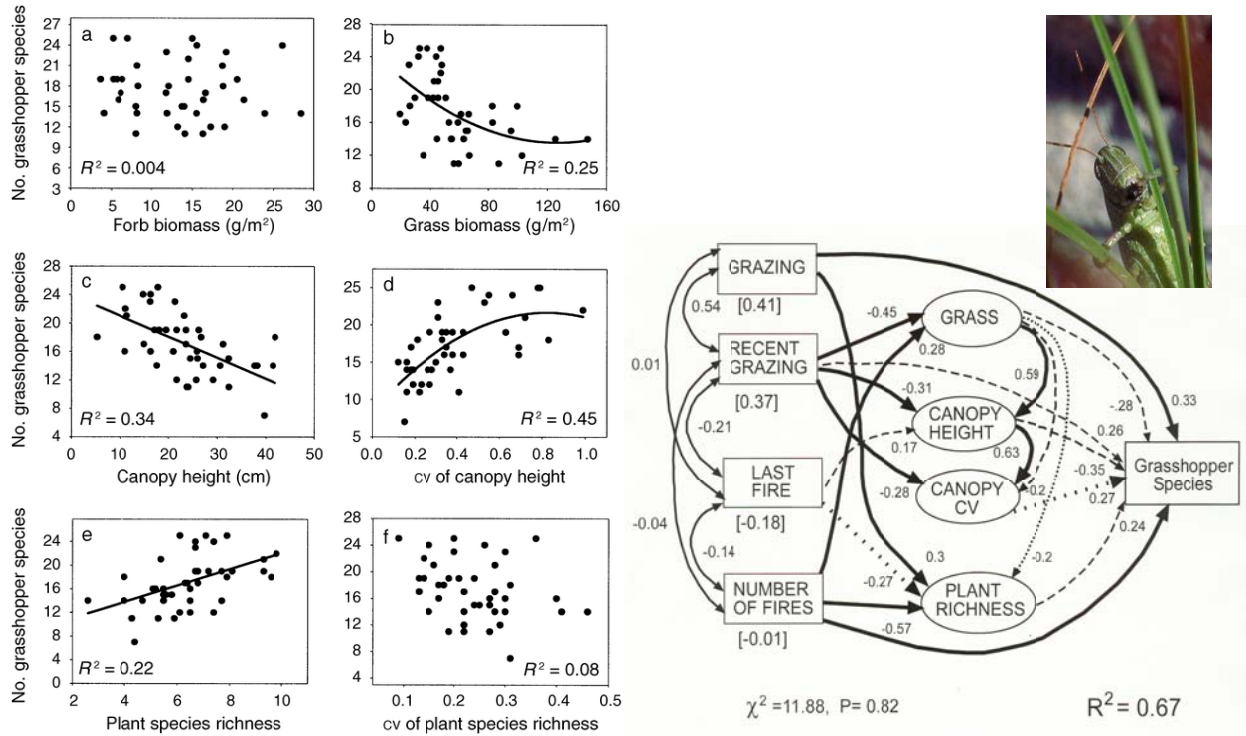
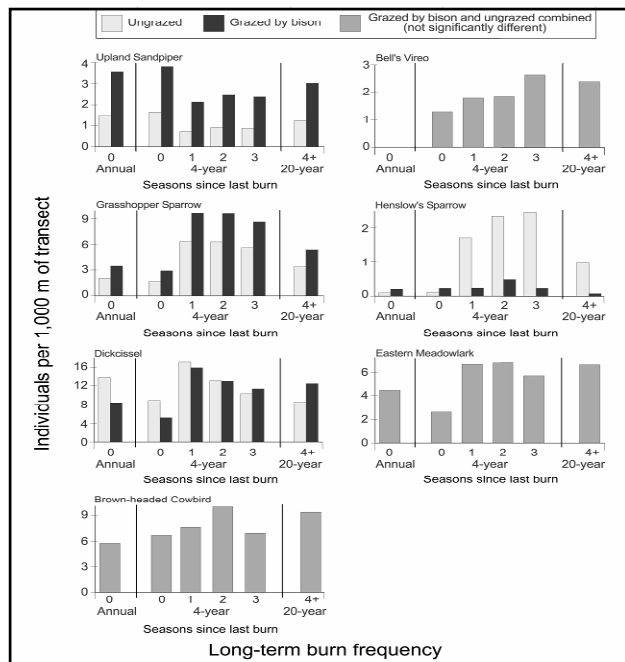

Fig. 20. *Left:* Relationship between grasshopper species richness and habitat characteristics (from Joern 2005). No significant relationship is observed between grasshopper species richness and (a) forb biomass or (f) the CV of plant species richness at a site. Significant regressions are seen for (b) grass biomass, (c) average canopy height, (d) CV of canopy height (local-scale structural heterogeneity), and (e) plant species richness. *Right:* Structural Equation Model (SEM) analysis illustrating the contributions of key habitat attributes and land management practices to grasshopper species richness.



Fig. 21. Effect of fire frequency and bison grazing on relative abundance of grassland bird species. Fire-grazing interactions influence abundance of many grassland species, including Upland Sandpipers (shown above), Henslow Sparrows, Grasshopper Sparrows, and Dickcissels (from Powell 2006).



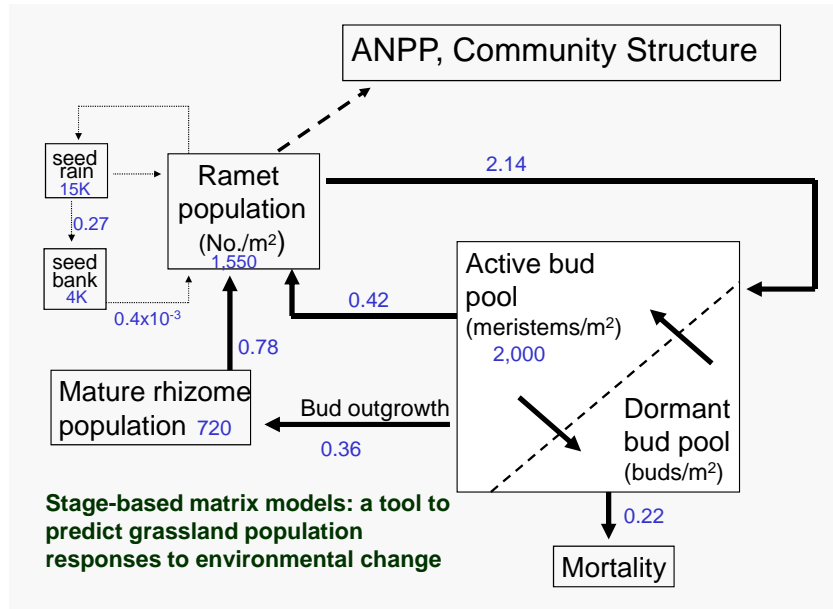

Fig. 22. *Left:* Belowground meristems (buds) that will give rise to new tillers of the dominant grass *Andropogon gerardii*. *Right:* A staged-based matrix model of plant population dynamics that includes ramet/tiller recruitment from belowground bud banks, which will be used to link plant demographic processes to changes in plant communities and ecosystem processes and to predict long-term responses to changes in key environmental drivers (*i.e.*, ANPP).

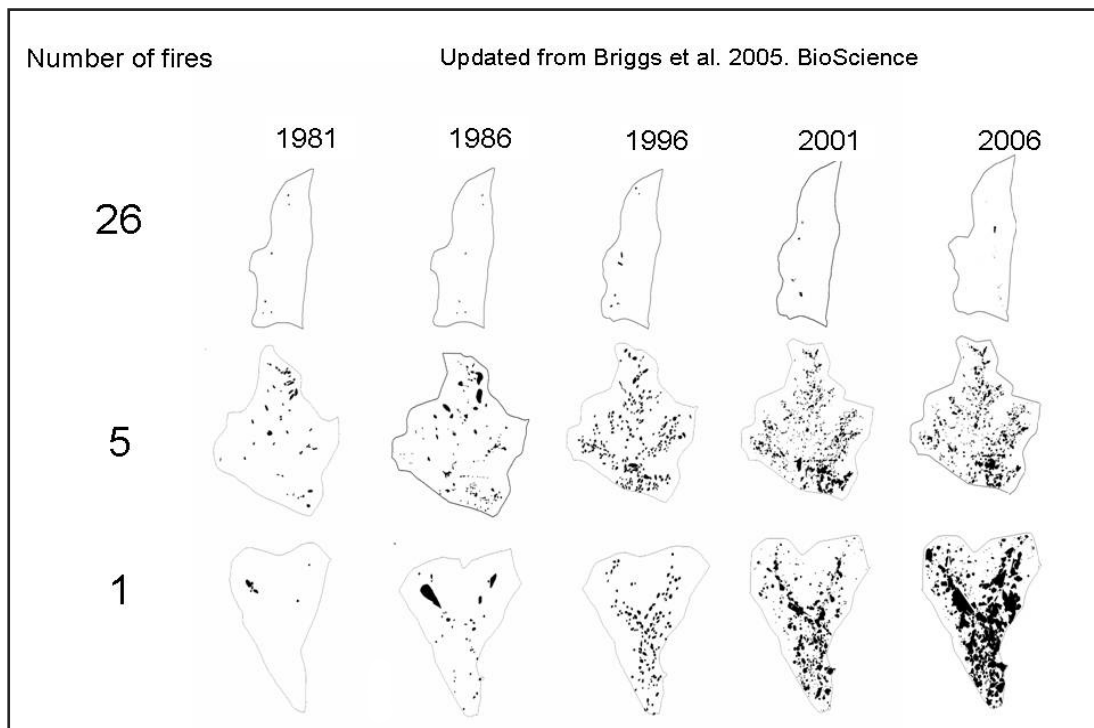

Fig. 23. The change in cover of woody vegetation over a 25-yr period on three watersheds at the Konza Prairie Biological Station subjected to three different burning treatments: burned annually (top series), burned every 4 years (middle series), and burned once in 20 years (bottom series). From Briggs *et al.* 2005

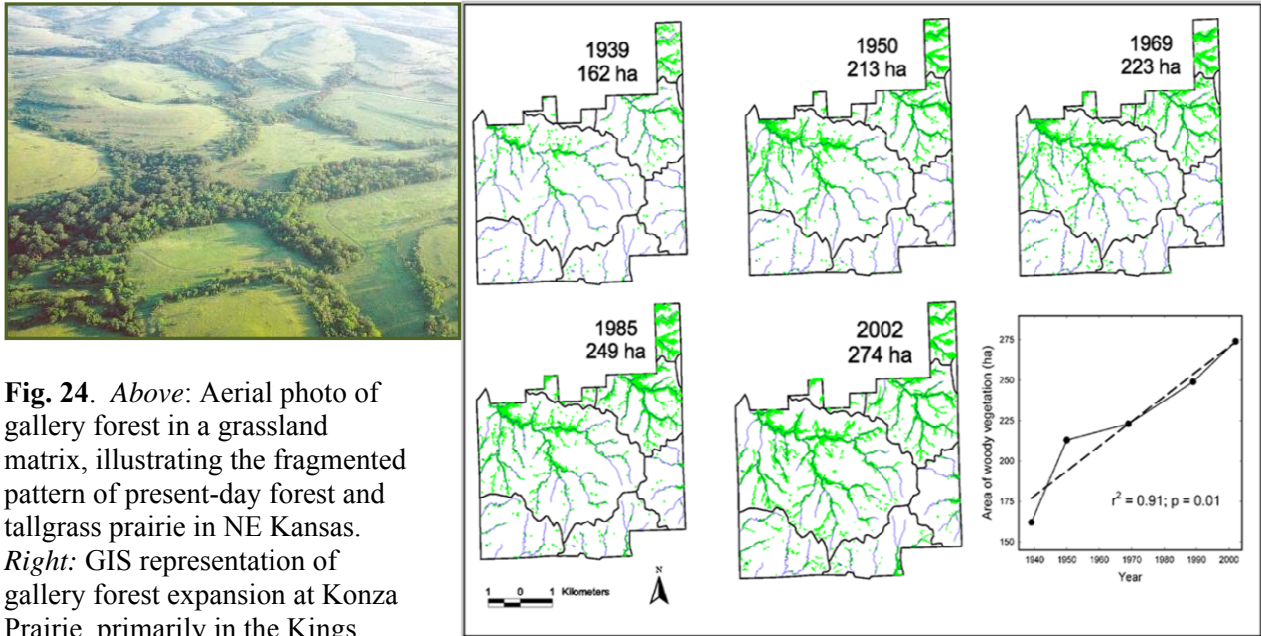

Fig. 24. Above: Aerial photo of gallery forest in a grassland matrix, illustrating the fragmented pattern of present-day forest and tallgrass prairie in NE Kansas.

Right: GIS representation of gallery forest expansion at Konza Prairie, primarily in the Kings Creek and Shane Creek drainage basins. Based on digitized aerial photographs from 1939, 1950, 1969, 1985, and 2002. The extent of the gallery forest increased from 162 hectares (ha) to 274 ha between 1939 and 2002 (lower right panel).

Major drainage boundaries at the Konza Prairie Biological Station are outlined in black and major streams are outlined in blue. From Briggs *et al.* 2005.

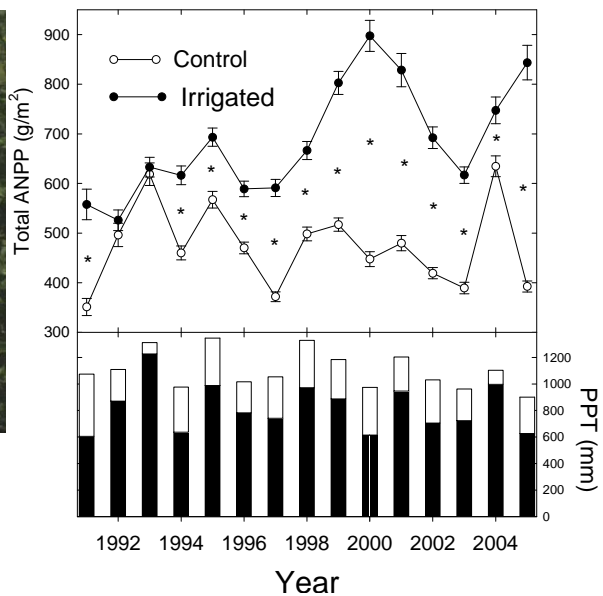

Fig. 25. Above: The Irrigation Transect experiment includes replicate irrigation and control transects spanning upland to lowland topographic positions to address the controls of water limitations in these grasslands (Knapp *et al.* 2001).

Left: The magnitude of the ANPP response to supplemental water has increased dramatically since 1999, which coincides with an increase in cover of the resource-demanding grass species *P. virgatum* (not shown here). This link between lagged community change and ecosystem response to a chronic change in resource availability is consistent with the HER model being evaluated in LTER VI (see Fig. 16).

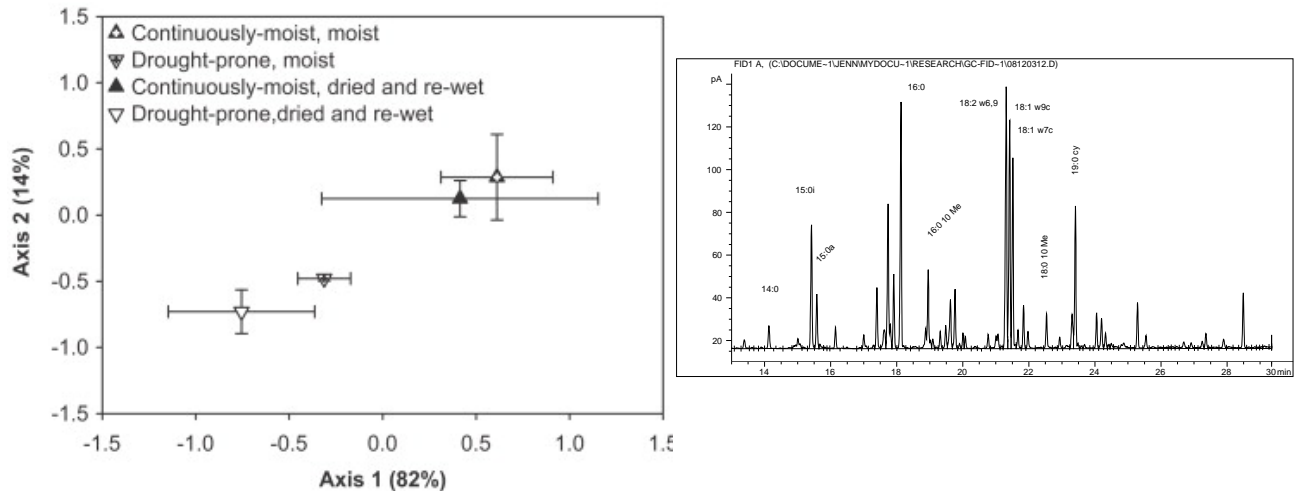

Fig. 26. Differences in the structure of the microbial community associated with long-term changes in water availability *in situ* (Irrigation Transect Experiment) vs. short-term wetting-drying in the laboratory based on non-metric multidimensional scaling (NMS) analysis of the mol% PLFA-C. (left panel) Continuously-moist=Irrigated transects and Drought-prone=control transects, while treatment designations “moist” and “dried and re-wet” refer to lab-induced water stress (Williams 2007). Percentages are variabilities associated with each axis. Symbols represent treatment means, \pm SEs on axes 1 and 2. Soils that were irrigated or subject to seasonal drought for 11 yrs responded to wetting and drying in the lab similarly. However, 11 yrs of irrigation resulted in significant changes in microbial community composition as reflected by PLFA. (e.g., right panel).

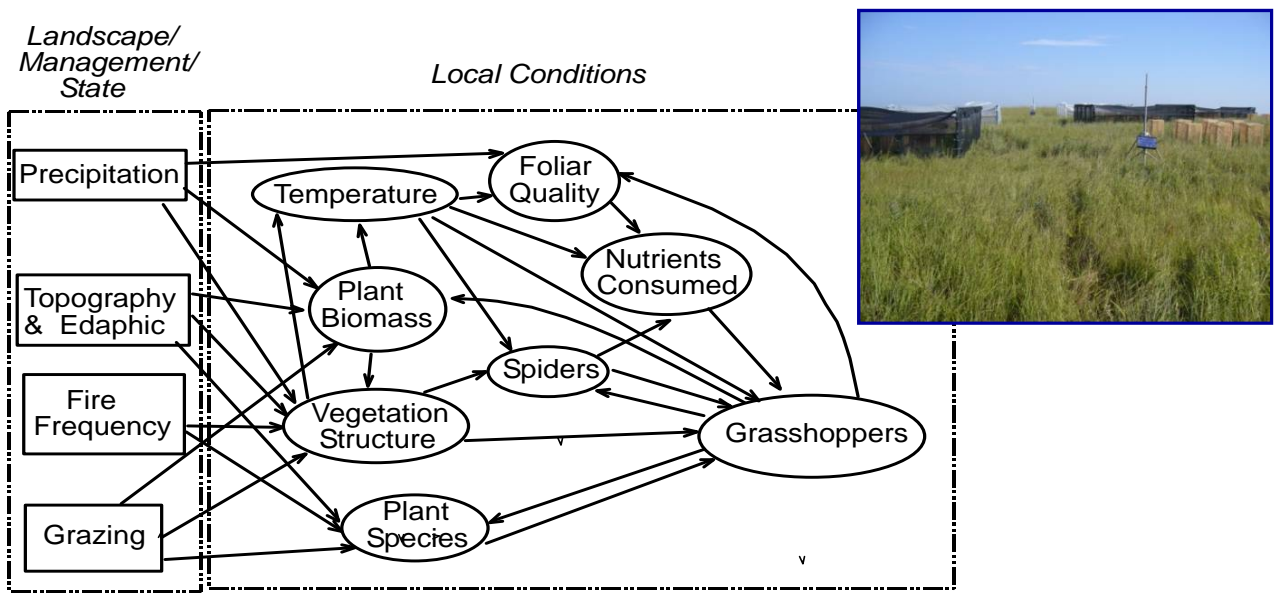

Fig. 27. Conceptual diagram behind new field-based climate change studies on the impacts of altered thermal regimes on grassland arthropod food webs and tri-trophic interactions. *Inset photo:* Spider-grasshopper experimental arenas. Temperature is manipulated by enclosing cages under plastic sheeting or shade cloth for part of the day (early morning) and comparing responses with cages experiencing ambient thermal conditions.

Fig. 28. Photograph and experimental design of the Belowground Plot Experiment, initiated in 1986. This experiment provides a long-term platform for research on



linkages between above- and belowground responses to fire, mowing and nutrient additions in mesic grasslands. New research for LTER VI will focus on an intensive synoptic sampling of above- and below-ground communities resulting from interactions of long-term nutrient enrichment and fire-mowing treatments.

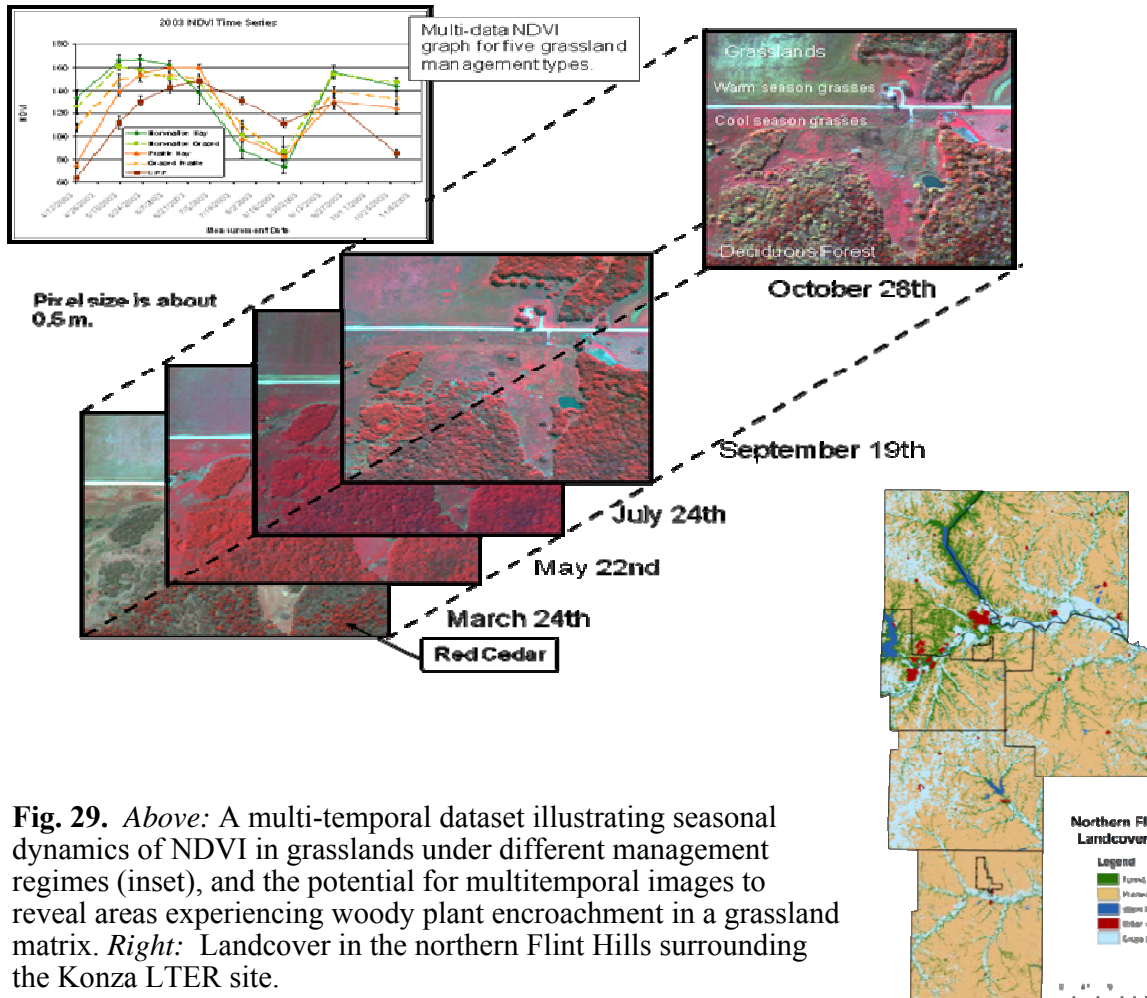
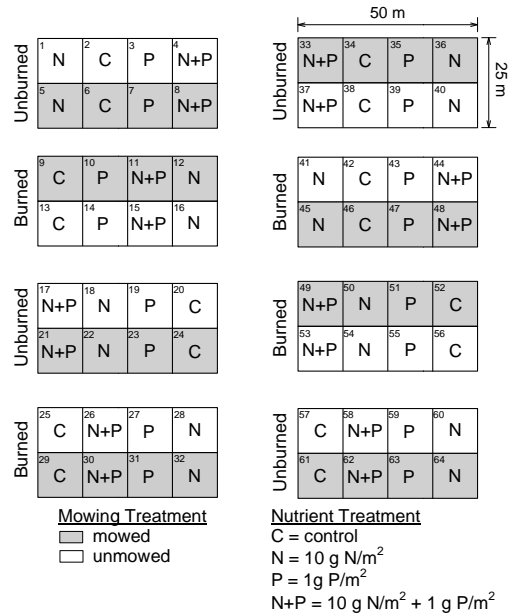

Fig. 29. Above: A multi-temporal dataset illustrating seasonal dynamics of NDVI in grasslands under different management regimes (inset), and the potential for multitemporal images to reveal areas experiencing woody plant encroachment in a grassland matrix. Right: Landcover in the northern Flint Hills surrounding the Konza LTER site.

III. PROGRAM MANAGEMENT

One of the original goals of the founding architects of the LTER Program was that long-term, site-based research programs with a relatively stable funding base would be managed in such a way that turnover of individual investigators and/or completion of scientific careers would not be detrimental to the central goals, experiments established, and the data collection efforts of the LTER sites (Callahan 1984). The Konza Prairie LTER site has been a successful test of this model. A group of KSU faculty led by G. Richard Marzolf initiated LTER I (1981-1986), implementing the site-based fire and grazing experiment designed by Lloyd Hulbert. The Konza LTER program was greatly expanded during LTER II (1986-1990), under the leadership of Don Kaufman and Tim Seastedt (Co-PIs during LTER I). Following Seastedt's departure in 1991, Alan Knapp and John Briggs provided leadership and administration for LTER III (1991-1996), with co-PIs David Hartnett and Don Kaufman serving in advisory roles. Leadership during LTER IV (1996-2002) was provided by Alan Knapp, John Blair and John Briggs, with co-PIs Hartnett, Kaufman, Dodds and Johnson. Blair assumed administrative responsibilities at the midpoint of LTER IV, and served as lead PI of LTER V, with Knapp, Briggs, Hartnett and Johnson, Dodds and Kaufman as Co-PIs. Blair will continue to serve as Lead PI for LTER VI with Dodds, Joern, Hartnett and Nippert as Co-PIs, and Briggs, Knapp, Kaufman and Johnson continuing to have significant input as Senior Personnel. In fact, Briggs will formally join the KSU faculty in 2008 as Professor and Director of the Konza Prairie Biological Station, a new position created to support continued growth of the Konza site and research base. An important reason for the continued scientific success of the KNZ LTER program has been shared intellectual leadership, and continuity of Co-PIs with substantial advisory roles. In addition, Konza investigators who have taken academic appointments elsewhere (*e.g.*, Knapp and Whiles) have continued their involvement in the KNZ LTER program. Likewise, several former graduate students and post-docs with significant LTER experience have continued to conduct, and in many cases lead, KNZ LTER research in new faculty positions at other institutions (*e.g.*, Baer, Fay, Smith).

Our management model depends on shared intellectual leadership and group decision-making. Our current LTER organizational scheme is depicted in Fig. 30. Blair serves as PI-of-record and primary KNZ LTER point-of-contact at the local (University) and LTER Network level. Day-to-day administrative decisions are handled by the PI, while input on matters that may significantly affect specific research groups or the KNZ program as a whole, is provided by co-PI's and Senior Personnel, as appropriate. We have a KNZ LTER Scientific Steering Committee, consisting of all LTER Co-PIs plus other key senior personnel, collaborators and staff scientists. The Steering Committee meets for strategic planning following our annual research meeting, and as needed during the year to make decisions regarding scientific direction of the KNZ research program. Konza LTER researchers are clustered into research groups, based on common research approaches and/or questions, with designated leaders for each group (Fig. 30). Group leaders are consulted as required when major research decisions must be made, or when specific requests for information or collaboration are received. Data requests and questions about specific datasets or LTER experiments are directed to the investigator assigned responsibility for the relevant data set. The willingness of group leaders and other senior personnel to deal with these latter types of requests reduces the workload on the lead PI substantially, and allows for greater coordination of this diverse research program. We also recently established a formal LTER Personnel Committee (Dodds, Joern and Gido) to set annual goals, provide evaluations, and make progress reports to Blair. To further reduce the administrative burden on the lead PI, we will hire an LTER administrative assistant with additional funding provided in LTER VI (as recommended in our last site review).

Another feature of our administrative model is maximizing the involvement of KNZ personnel in LTER Network activities. Blair serves as the KNZ representative to the LTER Science Council, with other KNZ co-PIs or Senior Personnel participating in Science Council meetings as appropriate. Minutes from these meetings are distributed to the entire KNZ group. Other LTER workshop participation is encouraged and supported whenever possible, especially for the LTER All Scientist Meeting. A large proportion of our faculty and graduate students are supported to attend this meeting.

We encourage collaboration and promote scientific and programmatic interactions among Konza LTER investigators using a variety of avenues for information sharing. All investigators (at Kansas State University and at other campuses) are included on appropriate e-mail lists through which information and requests are distributed. For example, LTER Network Office e-mail communications sent to the lead PI or “site-exec” are routinely forwarded to the KNZ Executive or Scientific Steering Committees or, if appropriate, to all KNZ investigators. In addition, a Konza listserv (Konza-l) provides a means of broadcasting announcements and disseminating information to all Konza researchers. During the academic year, a weekly research meeting is held for all Konza scientists and graduate students. General announcements and research presentations comprise the format of these meetings. Once a month the meeting is dedicated to LTER planning or discussion of issues directly related to local or network-level LTER activities. On an annual basis, we host a Konza Prairie LTER Workshop (the 18th was held in 2007). Both off-campus researchers and local scientists at all levels attend these all-day workshops. Faculty, post-docs, graduate and undergraduate students are invited to present research results as oral or poster presentations, with ample opportunities for informal interactions as well as a formal planning meeting for the Scientific Steering Committee and other senior personnel.

Although we follow a distributed model in terms of scientific/intellectual leadership and decision-making, we also recognize the need for external input into our research program. In addition to the NSF-led site reviews that occur once each funding cycle, we have also invited informal review teams to evaluate our program in the past, and sponsored “targeted” individual visits by non-Konza LTER scientists. We have found the targeted visits by external scientists to be of greatest value. These provide more in-depth review of one or more aspects of our program. Often we can combine these visits with a Division of Biology seminar presentation to reduce costs and maximize information exchange. Our goal is for each major research group to invite an outside expert to review their program over the LTER VI funding cycle.

Finally, an additional benefit of the distributed management of the Konza LTER program is the broad-based research program that results when such a large group of scientists is actively involved in a common program. This proposal is a prime example, with the project objectives and approaches being proposed and refined with input from individual investigators and diverse research groups. Due in part to this open research model, we have been very successful at attracting additional scientists, from both KSU and other institutions, to participate in Konza research and we will continue to expand our “scientific diversity” through LTER VI. In addition to the new faculty members with LTER interests recently hired in Biology (Samantha Wisely 2004, Tony Joern 2005, Jesse Nippert 2007, Joe Craine 2007), we have encouraged and supported where possible, new Konza research by faculty members in other departments at KSU (John Harrington, Geography; Stacey Hutchinson, Civil Engineering; Kendra McLaughlin, Geography; Kevin Price, Agronomy and Geography) and from other institutions (Sara Baer and Matt Whiles, University of Southern Illinois; Melinda Smith, Yale). In particular, we have made an effort to support junior faculty members, and to promote gender equity (e.g., new KNZ leadership includes Assistant Professors Melinda Smith and Sara Baer). The KSU administration has been highly supportive, with targeted hires in Biology (see letters of support in Budget Justification) and other Departments, and new position created by the Central Administration for the Konza Prairie Biological Station Director.

The availability of KNZ resources and LTER data has been invaluable in attracting non-KSU investigators and is made possible by the cooperation of all KNZ LTER scientists. We will continue to encourage use of the Konza site and KNZ LTER data by additional investigators as opportunities arise, through a variety of mechanisms, including on-site research support, support for new graduate students, opening the process of applying for LTER supplements to new researchers, providing LTER “seed money” to researchers that get involved during the course of LTER VI and, where feasible, more formal subcontracts.

Fig. 30 – Organizational structure of the Konza Prairie LTER Program

Executive Committee/PIs

J. Blair, W. Dodds, D. Hartnett, A. Joern, J. Nippert

Scientific Steering Committee (in addition to PIs)

S. Baer, J. Briggs, K. Gido, J. Harrington, D. Kaufman, A. Knapp, B. Sandercock, M. Smith

Konza LTER Staff

Jincheng Gao (Information Manager); G. Kaufman (Small Mammal Studies); Amanda Kuhl (Field Coordinator); Rosemary Ramundo (Lab Coordinator); Gene Towne (Plant Sampling and Bison Management); Valerie Wright (Schoolyard LTER Coordinator); Administrative assistant (TBD)

Konza LTER Research groups

Primary affiliations are indicated, but most researchers participate in several groups. Asterisks indicate group leaders/co-leaders who serve as primary contacts for the group

<u>Abiotic Environment</u>	<u>Fire/Grazing Studies</u>	<u>Woody Plant Expansion</u>	<u>Restoration Ecology</u>	<u>Climate & Climate Change</u>	<u>Aquatic Ecology</u>
P. Fay	J. Blair	J. Briggs*	S. Baer*	J. Blair*	W. Dodds*
J. Gao	J. Briggs	W. Dodds	J. Blair	P. Fay	K. Gido*
D. Goodin	S. Collins	J. Ham	S. Collins	J. Ham	J. Koelliker
J. Ham	J. Craine	D. Kaufman	L. Johnson	J. Harrington	G. Macpherson
J. Harrington	J. Gao	G. Kaufman	D. Kaufman	D. Hartnett	M. Whiles
S. Hutchinson	K. Garrett	A. Knapp	G. Kaufman	S. Hutchinson	
J. Koelliker	D. Goodin	K. McLauchlan	C. Rice	A. Joern	
G. Macpherson	D. Hartnett*	J. Nippert	T. Todd	G. Kaufman	
J. Nippert*	E. Horne	K. Price	G. Wilson*	A. Knapp*	
	A. Joern*	B. Sandercock*		G. Macpherson	
	L. Johnson			K. McLauchlan	
	D. Kaufman			J. Nippert	
	A. Knapp			C. Rice	
	J. Nippert			B. Sandercock	
	M. Smith			M. Smith	
	G. Towne				
<u>Terrestrial Nutrient Enrichment</u>	<u>Modeling/Regionalization</u>	<u>Biodiversity & Systematics</u>	<u>Synthesis</u>	<u>Socio-Ecological Systems</u>	<u>Education & Outreach</u>
J. Blair*	J. Blair	C. Ferguson*	J. Blair	J. Blair	J. Blair*
J. Craine	J. Briggs	K. Gido	J. Briggs	J. Briggs	J. Briggs
D. Hartnett	K. Garrett	A. Joern	S. Collins	D. Goodin	W. Dodds
L. Johnson	D. Goodin*	A. Jumpponen	W. Dodds	J. Harrington*	D. Hartnett
A. Jumpponen	J. Harrington	D. Kaufman	D. Hartnett	D. Hartnett	E. Horne
C. Rice	L. Johnson	G. Kaufman	A. Joern*	S. Wisely	B. Sandercock
M. Smith*	B. McKane	B. Sandercock	D. Kaufman		G. Towne
T. Todd	K. Price*	M. Whiles*	A. Knapp*		V. Wright*
M. Whiles	S. Wisely	G. Zolnerowich	R. McKane		
			J. Nippert		

IV. DATA AND INFORMATION MANAGEMENT

The Konza Prairie LTER (KNZ) Information Management System (IMS) includes people, hardware, and software to store and deliver scientific information in order to facilitate interdisciplinary research and scientific discovery. The overarching goals of the KNZ IMS are to (1) assure data integrity (correctness at all times of all items in the database), (2) improve data security (protection against data loss), (3) facilitate access to datasets and metadata by the original investigator(s) and by other researchers within and outside of the LTER network, and (4) enhance the usability of data and metadata for current and future generations of scientists and students.

Since its inception in 1981, the KNZ IMS has evolved from serving a local research group at Kansas State University (mostly in the Division of Biology) to functioning as part of diverse LTER program comprising a multi-disciplinary team of investigators from numerous universities and government agencies. During the early 1980's, considerable effort was made by the Konza LTER Information Manager (IM) and support staff to implement a base-level research data management plan. Its primary goal was to allow researchers to locate, interpret and use Konza data. This plan was designed using guidelines established by Gorenz *et al.* (1983) and is documented in Gurtz (1986). The development of the original KNZ database system has been summarized by Briggs and Su (1994) and Briggs (1998). While the Konza LTER IMS led the development and implementation of our IMS, they have also participated in our LTER program as scientists and researchers, and all have contributed significantly to the scientific mission of the KNZ LTER program as evidenced by the KNZ publication database (see citations for Briggs, Brock, and Gao).

The Konza IMS includes a local network with ~70 terminals (~50 workstations and ~20 laptops) and five servers on the KSU campus and a wireless network at the Konza Prairie Biological Station (implemented during LTER V). In 2004, we changed the KNZ network operating system from Novell to Windows 2003. At the same time we migrated all of our databases to the new servers in their original ASCII format (see below), we also established new data and metadata databases with SQL Server 2000. The following five servers are the current core hardware for the Konza LTER IMS:

- a SQL Server 2000 database server for Konza data and metadata management
- a Microsoft Windows 2003 domain controller for maintaining data files and serving applications for the local LTER group
- a Microsoft Windows 2003 web server for hosting Konza LTER web sites, and providing an interface for data dissemination
- a Microsoft Windows 2003 domain controller for managing local network
- a spatial data workstation/server for spatial data management including Konza GIS data and remotely sensed images

There are currently 115 individual datasets included under 72 major datasets (listed by dataset code in *Supplemental Documents*) collected and managed by KNZ LTER program including 49 core long-term datasets (10+ yrs) and 23 shorter-term dataset categories (< 10 yrs). Note some major datasets have multiple individual datasets (identified by different record codes) nested within them. Our goals are to provide on-line access for all LTER data within one-year of data collection, processing and appropriate quality control. Within the constraints of resources available for sample processing, data entry and quality control, we give highest priority to archiving and placing on-line the core long-term data collected as part of the KNZ LTER program, mostly at the Konza Prairie site, in order to facilitate data access and sharing.

Prior to 2004, all non-spatial LTER data were organized by dataset catalog code and stored in a flat ASCII text format on the Konza server, and were made accessible through the KNZ LTER website (www.konza.ksu.edu). Storing data in an ASCII format meant that it was easily edited and transferred among computers with different operating systems (*e.g.*, UNIX, MAC, and Windows) and software. However, updating flat ASCII files is relatively time-consuming when new data are added to growing

datasets, and it is difficult to automate quality assurance / quality control checking with this file structure. Therefore, starting in 2004, we began to transfer data from the original text files into our new SQL Server database, where the data are organized with the original dataset codes, along with additional explanatory metadata for each dataset. The migration of data from some datasets has been relatively easy (*e.g.*, climate, ANPP), while other more complex datasets required some significant restructuring. In addition, some LTER researchers continue to use data-processing and reduction programs that were created specifically for the original ASCII data files. Therefore, we have opted to maintain all data files in their original ASCII formats while we work on completing the conversion of all datasets to the SQL Server database (on our current web site both formats are currently accessible for datasets that have been converted to SQL format, while the original ASCII format is accessible for all datasets). Once all data are transferred to the SQL Server database, we will work with original investigators to assure that all datasets meet investigator requirements before removing and archiving original ASCII data files.

Spatial data at the Konza LTER station are stored on the ArcSDE server. GIS coverages and remotely sensed images are viewable and downloadable online through our ArcIMS and ArcGIS spatial servers. Larger remotely sensed images, such as satellite images, are stored with CDs and DVDs. If required, the images can be downloaded from our web server through arrangement with the IM.

The Konza LTER IMS maintains a web-accessible, up-to-date database of all Konza LTER publications including journal articles, conference proceedings, books and book chapters, theses and dissertations, and electronic publications supported by Konza LTER program. We recently increased the functionality of the publication database by enabling a search by key words, author name, and date. Non-electronic materials including samples (plant and soil), specimens, documents, and photographs) are stored in various locations on the KSU campus and at KPBS, as appropriate. For example, voucher plant and insect specimens are stored in the KSU Herbarium or the KSU Museum of Prairie and Arthropod Research, respectively. The Konza IM has provided expertise on data management for both of these facilities, and has been instrumental in efforts to database and improve electronic access to specimen information. We have also provided access to Konza servers and electronic storage for these databases.

Metadata are an important part of data description, and are critical for long-term data management. Ecological Metadata Language (EML) is the standard adopted by the LTER Network. We are devoted to making all of our datasets meet this standard. Prior to 2004, all Konza LTER metadata were stored as pdf files. Now, Konza LTER metadata have been transferred into a newly designed metadata database in SQL Server. Level V EML metadata for each dataset is automatically generated from the SQL Server database. In addition, a separate XSLT-FO stylesheet was implemented to generate a PDF document version of the metadata, to provide maximum flexibility in metadata formats. Each online dataset has associated with it metadata in both PDF and EML formats that can be downloaded online. To date, we have harvested 66 EML documents, or 92% of our total dataset categories, into the LTER Network's Metacat. These harvested EML documents are valid EML and include information for identification, discovery, evaluation, access, and integration.

Data quality assurance / quality control are important for data integrity and management. Post-collection quality control of Konza LTER data is currently done by manual error checking by LTER data entry personnel, and supplemented with data range verification by computer. After data is input to the Konza IMS from a dedicated data input workstation, the data set is first saved as a text file. Data entry personnel check the text file multiple times to ensure there are no data entry errors. The error-checked dataset is then returned to the responsible investigator-of-record (each dataset is assigned to a specific Konza investigator), who provides a final data check. During the transfer of text files into database, there is an additional automated error check, including a data validation step using preset thresholds to limit data to an acceptable range.

The Konza LTER web site is widely used by the scientific community for research and education, and by the general public (see statistics on web usage and data hits in *Supplemental Documents*). As indicated, our data and metadata were originally stored in text format on our old web server

(<http://www.konza.ksu.edu>), but were difficult to maintain and to search, and were not consistent with new metadata standards developed by the LTER network. Therefore, we launched a new web site in 2004 (<http://www.konza.ksu.edu/konza>). For the current transition period, both ASCII and SQL versions of the data are accessible on the new web site. The metadata are stored in both EML and PDF formats that are easily accessed, downloaded, and subject to various search functions. Some search functions have been already implemented in the metadata, such as searchable publication and personnel databases, and new functionality will be added during LTER VI. The new web site is also controlled by master template and dynamic content. Web content and navigation are controlled by XML with connection to the database, and are dynamically loaded when pages are browsed. These web pages are easy to maintain and update, and it is easier to maintain consistency among pages.

We ask that manuscripts prepared using LTER data be provided to the LTER IM so that appropriate investigators may be notified, and so that we have a record of publications using Konza LTER data. We also request that investigators using LTER data adhere to the following guidelines (available on our website): We ask that all publications, reports and proposals using any data from KNZ acknowledge the KNZ program using the following statement: "Data for XXX was supported by the NSF Long Term Ecological Research Program at Konza Prairie Biological Station"; where XXX is the list of datasets used in the publications, reports or proposals.

Four specific enhancements to the Konza IMS program are planned for LTER VI:

1. We will continue to convert datasets from ASCII format into the SQL Server database, and add new datasets collected as part of LTER VI to LTER database. For example, new datasets associated with plant and community responses to patch fire-grazing experiments will be developed, and water sediment data associated with the riparian vegetation removal experiment and the patch grazing treatments in Shane Creek and dissolved oxygen measurements for metabolism from Kings Creek will be added in our database.
2. We will continue to improve and upgrade our EML metadata based on "best practices" established by the LTER information management community. For example, spatial attributes of each dataset were added to the metadata database and will be implemented in EML metadata. Key words will be added in publications and datasets.
3. We will create new search functions on our web site to facilitate metadata query and data mining. Typical search engines, like Google, work on static web pages, but not in dynamic pages. Our goal is to enable searching for information not only on static web pages, but also from our EML metadata. For example, searching publications with key words will return information on datasets related to the publications.
4. We will continue to develop and refine our GIS and Remote Sensing database. Many Konza GIS and remote sensing data layers are available on the Web via ArcIMS as interactive maps. We will store all GIS data and remote sensing data on an ArcGIS server to enhance the ability to data-mine spatial data, and to facilitate visualization and synthesis. Our goal is to move our online spatial database beyond its current role as a simple map visualization and query tool to a powerful data analysis tool that is integrated with our web pages.

V. OUTREACH AND EDUCATIONAL ACTIVITIES.

Educational activities associated with the Konza LTER program have increased throughout LTER V. Undergraduate and graduate student training is a core activity of the Konza LTER program. Forty-nine graduate student thesis and dissertations were completed during LTER V. A Konza Prairie site-based REU program was maintained (<http://www.ksu.edu/bsanderc/reu.html>), supporting an average of 10 undergraduates per year in addition to several LTER- and other grant-supported REU students annually. An education director (Dr. Valerie Wright) leads the Konza Environmental Education Program (KEEP) with her assistant Annie Baker. KEEP has a two-fold mission of increasing appreciation and understanding of natural ecosystems and of the process and value of science among K-12 students and the public (www.ksu.edu/konza/keep). A Konza Prairie Schoolyard LTER program was initiated in 1998, with emphasis on the development of realistic and relevant long-term research activities for K-12 students and their teachers as a means of educating students about the science of ecology. In 2005, the Konza SLTER program was expanded statewide with schools across Kansas collecting data and contributing to long-term databases at satellite prairie sites (Prairies Across Kansas). Prairies Across Kansas now accounts for 33% of the students participating in Konza Prairie K-12 education programs. SLTER and KEEP annually conduct over 125 programs, serving > 4,000 K-12 students, teachers, and other adults from throughout Kansas (Fig. 31). Approximately 30 private citizens are trained each year as docents for KEEP. They are liaisons with the public and volunteers for many activities on site. Numerous KNZ LTER senior scientists and graduate students participate in KEEP and SLTER student, teacher and volunteer training. Additional KPBS programs provide research experience opportunities for high school students, and these projects synergize the SLTER initiative. Konza has been the field site for a local high school summer field biology course for the last 10 years. During LTER V, KNZ became part of the KSU Girls Researching Our World (GROW) program. This program, funded by the NSF Gender Equity in SMET initiative, provides 6th-8th grade girls with exposure to science careers using environmental stewardship as a theme (www.ksu.edu/grow/). At the college level, KPBS serves as an outdoor educational laboratory for university classes and visiting field courses from numerous institutions each year. Senior KNZ scientists often present to these groups. Information about these opportunities on KPBS is made available through its membership in the Organization of Biological Field Stations, Association of Ecosystem Research Centers, and other organizations

Konza Prairie and the LTER program have actively integrated undergraduates into research and have provided many training opportunities through the REU program and employment. In a 5-yr period (2002-07), 23 KNZ scientists served as mentors for 55 student participants in an NSF-funded Research Experiences for Undergraduates Site Program. REU participants were recruited from 41 institutions in 27 states, and included 32 women and 20 minority students (12 Native, 7 Hispanic, and 1 African-American). Konza also hosted students in 2006 from the joint LTER/ Ecological Society of America's Strategies for Ecology Education, Development and Sustainability (SEEDS) program (Fig. 32). Attendees included 19 students from 16 schools across the country, including the territories of American Samoa and Puerto Rico; one SEEDS faculty from Yale University; and three SEEDS staff from the Ecological Society of America. During LTER V, 28 Konza Prairie undergraduates have published papers (as senior author or co-author) in national peer-reviewed journals. Also, the majority of Konza REU students have completed senior honors theses and/or presentations at national meetings based on their KPBS research.

Results from KNZ studies are increasingly used in undergraduate ecology texts and other teaching materials. For example, Konza LTER studies demonstrating the role of fire and grazing in grasslands are prominently featured in *General Ecology*, 2nd edition by D.T. Krohne, and a recent Konza study by Collins *et al.* is a featured "case study" in the on-line supplement to *Ecology Theory and Applications* 3rd edition by Stiling. Data from KNZ aquatic programs are featured in *Freshwater Ecology* by Dodds. Two undergraduate field teaching exercises using Konza LTER data have been developed and published in the ESA's *Teaching Issues and Experiments in Ecology* (Nippert & Blair 2005, Dalgleish & Woods 2007).

Konza Prairie scientists deliver numerous presentations and talks each year to various civic groups and educational, professional, and conservation organizations and agencies (*e.g.*, The International Grassland Congress, Grassland Society of Southern Africa, The Nature Conservancy, National Parks

Conservation Association, National Bison Association, KS Dept. of Wildlife & Parks). During LTER V, we hosted several professional meetings, and workshops, including The Nature Conservancy's Flint Hills Initiative Workshop, US Forest Service Fire Manager's Workshop, Tallgrass Legacy Alliance workshop, the Kansas Center for Sustainable Agriculture Workshop, and site visits from scientist groups from Reserva de la Biosfera del Osque Mbaracayu, Archbold Biological Station, The Kansas Grazers Association, the KS Rural Center, and Ted Turner and Turner Ranches. In 2004, Konza hosted the 31st Annual Kansas Herpetological Society meeting.

Konza LTER scientists and the LTER database have continued to contribute to a number of important outreach activities of local, regional, national and international significance. At a local level, KNZ scientists participate in Kansas Agricultural Experiment Station public education events, and host a biennial Visitors' Day (~1500 people/yr), featuring LTER research results and education programs. Konza LTER scientists have been actively involved at the state level in two major projects: 1) KNZ researchers designed interpretive materials for a tallgrass prairie scenic overlook (including prairie walkway and information kiosk) on a state highway bordering KPBS, and 2) Konza LTER PIs are currently involved in the planning and design of a Flint Hills Tallgrass Prairie Interpretive Center, planned for construction on the Interstate 70 corridor adjacent to KPBS. At the regional level, the KNZ-LTER databases on the effects of fire and grazing on tallgrass prairie ecosystems continue to be instrumental to the NPS in their development of a scientifically sound management plan for National Park's Tallgrass Prairie Preserve. In addition, KNZ results are used by The Nature Conservancy's (TNC) "Flint Hills Initiative", a program to develop ecologically sound management and preservation strategies for the Flint Hills and broader tallgrass prairie region. Brian Obermeyer, the leader of that program, interacts extensively with KNZ scientists to summarize and incorporate LTER results into regional grassland management.

National visibility of the Konza LTER program has also increased significantly in recent years as it has been the focus of several major projects. An educational documentary film entitled *Last Stand of the Tallgrass Prairie*, funded by NSF, EPA, NEA, and several corporate sponsors, was aired nationally by PBS beginning in 2001 and is continuing to the present. A second documentary also featuring Konza LTER studies, *Tallgrass Prairie: The Lost Landscape* aired nationally by PBS in 2005. Konza scientists were also involved in production of a major educational exhibit entitled "Listening to the Prairie" which premiered at the Smithsonian Institution traveled to libraries and museums throughout the U.S. during 2002-2004. A National Geographic cover article on the Flint Hills tallgrass prairie (2007) also prominently featured contributions of the Konza Prairie LTER program.

In the international arena, the Konza LTER program has also attracted visiting scientists and natural resource managers from 11 different countries, with many of these visits focusing on resource management issues of public concern.

Our goals for LTER VI are to maintain our strong tradition of education and outreach, and to continue to expand the educational activities of KNZ. KEEP/SLTER is seeking funding to expand volunteer training into small communities in Kansas where schools currently participate in SLTER/PAK. We plan to build communities of citizen ecologists who will become more environmentally literate, collect biological data (such as plant and animal inventories, photo archives of ecosystem changes over time and phenological events), and learn the process of science. Some of these citizen ecologists will become docents to help with school field activities associated with PAK. A major facilities renovation program, currently in progress, will greatly enhance the capacity of KPBS to provide research opportunities and science education programs. With support from the NSF Field Stations and Marine Laboratories Program, the Kansas Agricultural Experiment Station, KSU, and private foundations, major site improvements and building renovations including new housing facilities for visiting students and scientists were completed during LTER V, and a recent NSF-FSML grant has provided funding for the renovation of the historic limestone barn at headquarters into a new multipurpose meeting facility for on-site conferences, workshops, and educational programs. In addition, numerous grants from state agencies and private foundations have supported enhancements to the public interpretive trails facilities, educational materials, and the construction of an outdoor education center.



Fig. 31. Activities of the Konza Schoolyard LTER (SLTER) program. The Hulbert Research Center (upper left) houses laboratory and classroom facilities for the SLTER Program. Student activities are lead by the Konza Environmental Educator, Dr. Valerie Wright (*upper right*). Students and their teachers participate in SLTER studies, and add to their own long-term datasets, as a means of learning about grassland ecology and the enterprise of science (*below*).



Fig. 32. In 2006, the Konza LTER program hosted an ESA SEEDS field trip. *Above left*: SEEDS student collects data on Konza Prairie bird populations with Jim Rivers, a summer resident PhD student from UC Santa Barbara. *Above right*: Dr. Sara Baer talks to SEEDS students about grassland restoration research and the application of ecological principles to grassland conservation.

Literature Cited

- Abrams, M.D. 1985. Fire history of oak gallery forests in a northeast Kansas tallgrass prairie. *American Midland Naturalist* 114:188-191.
- Abrams, M.D. 1986. Historical development of gallery forests in northeast Kansas. *Vegetatio* 65:29-37.
- Abrams, M.D. 1992. Fire and the development of oak forests. *Bioscience* 42:346-353.
- Adler, P.B., J. HilleRisLambers, P.C. Kyriakidis, Q. Guan, and J.M. Levine. 2006. Climate variability has a stabilizing effect on the coexistence of prairie grasses. *Proceedings of the National Academy of Science* 103:12793-12798.
- Adler, P.B., E.P. White, W.K. Lauenroth, D.M. Kaufman, A. Rassweiler, and J.A. Rusak. 2005. Evidence for a general species-time-area relationship. *Ecology* 86:2032-2039.
- Aerts, R. and F.S. Chapin. 2000. The mineral nutrition of wild plants revisited: a reevaluation of processes and patterns. *Advances in Ecological Research* 30:2-67.
- Agrawal, A.A., D.D. Ackerly, F.R. Adler, A.E. Arnold, C. Caceres, D.F. Doak, E. Post, P.J. Judson, J. Maron, K.A. Mooney, M.E. Power, D. Schemske, J.J. Stachowicz, S.Y. Strauss, M.G. Turner, and E.E. Werner. 2007. Filling key gaps in population and community ecology. *Frontiers in Ecology and the Environment* 5:145-152.
- Albertson, F.W., and J.E. Weaver. 1954. Nature and degree of recovery of grassland from the great drought of 1933 to 1940. *Ecological Monographs* 14:395-479.
- Aleinikoff, J.N., D.R. Muhs, R. Sauer, and C.M. Fanning. 1999. Late Quaternary loess in northeastern Colorado, Part II—Pb isotopic evidence for the variability of loess sources. *Geological Society of America Bulletin* 111:1876–1883.
- Anderson, R.C. 1990. The historic role of fire in the North American Grassland. Pages 8-18 in S.L. Collins and L. L. Wallace (eds.) *Fire in North American Tallgrass Prairies*, University of Oklahoma Press, Norman, OK.
- Anderson, T.M., M.E. Ritchie, E. Mayemba, S. Eby, J.B. Grace, and M.M. McNaughton. 2007. Forage nutritive quality in the Serengeti ecosystem: the roles of fire and herbivory. *American Naturalist* 170:343-357.
- Archer, S.R., D.S. Schimel, and E.H. Holland. 1995. Mechanisms of shrubland expansion: Land use, climate or CO₂? *Climatic Change* 29:91–99.
- Archibald, S., W.J. Bond, W.D. Stock, and D.H.K. Fairbanks. 2005. Shaping the landscape: fire-grazer interactions in an African savanna. *Ecological Applications* 15:96-109.
- Augustine, D.J., and D.A. Frank. 2001. Effects of migratory grazers on spatial heterogeneity of soil nitrogen properties in a grassland ecosystem. *Ecology* 82:3149-3162.
- Augustine, D.J., and S.J. McNaughton. 1998. Ungulate effects on the functional species composition of plant communities: herbivore selectivity and plant tolerance. *Journal of Wildlife Management* 62:1165-1183
- Axelrod, D.I. 1985. Rise of the grassland biome, central North America. *Botanical Review* 51:163-201.
- Baatz, M., & Schäpe, A. 2000. Multiresolution segmentation - an optimization approach for high quality multi-scale image segmentation. Pages 12-23 in J. Stobl, Blaschke, T., & Griesebner, G. (eds). *Angewandte Geographische Informationsverarbeitung XII*. Heidelberg, Germany: Wichmann-Verlag.
- Baer, S.G., and J.M. Blair. (in press) Grassland establishment under varying resource availability: A test of positive and negative feedback. *Ecology*.

- Baer, S.G., J.M. Blair, S.L. Collins, and A.K. Knapp. 2003. Soil resources regulate productivity and diversity in newly established tallgrass prairie. *Ecology* 84:724-735.
- Baer, S.G., J.M. Blair, S.L. Collins, and A.K. Knapp. 2004. Plant community responses to resource availability and heterogeneity during restoration. *Oecologia* 139:617-639.
- Baer, S.G., S.L. Collins, J.M. Blair, A.K. Knapp, and A. Fiedler. 2005. Soil heterogeneity effects on tallgrass prairie community heterogeneity: An application of ecological theory to restoration ecology. *Restoration Ecology* 13:413-424.
- Baer, S.G., D.J. Kitchen, J.M. Blair, and C.W. Rice. 2002. Changes in ecosystem structure and function along a chronosequence of restored grasslands. *Ecological Applications* 12:1688-1701.
- Bailey, D.W., J.E. Gross, E.A. Laca, L.B. Rittenhouse, M.B. Coughenour, D.M. Swift, and P.L. Sims. 1996. Mechanisms that result in large herbivore grazing distribution patterns. *Journal of Range Management* 49:386-400.
- Bailey, D.W. and M.F. WallisDeVries. 1998. Utilization of heterogeneous grasslands by domestic herbivores: theory to management. *Zootechnology* 47:321-333.
- Baker, P.K. 2007. Ecosystem consequences of invasive exotic species in grasslands. MS Thesis, Colorado State University. Fort Collins, CO. 55 pp
- Bakker, C., J.M. Blair, and A.K. Knapp. 2003. A comparative assessment of potential mechanisms influencing plant species richness in grazed grasslands. *Oecologia* 137:385-391.
- Bakker, E.S., M.E. Ritchie, H. Olf, D.G. Milchunas, and J.M.H. Knops. 2006. Herbivore impact on grassland plant diversity depends on habitat productivity and herbivore size. *Ecology Letters* 9:780-788.
- Barrett, J.E., R.L. McCulley, D.R. Lane, I.C. Burke, and W.K. Lauenroth. 2002. Influence of climate variability on plant production and N-mineralization in Central US grasslands. *Journal of Vegetation Science* 13:383-394.
- Benson, E., and D.C. Hartnett. 2006. The role of seed and vegetative reproduction in plant recruitment and demography in tallgrass prairie. *Plant Ecology* 187:163-177.
- Benson, E., D.C. Hartnett, and K. Mann. 2004. Belowground bud banks and meristem limitation in tallgrass prairie plant populations. *American Journal of Botany* 91:416-421.
- Bernot, M.J., and W.K. Dodds. 2005. Chronic nitrogen loading in streams. *Ecosystems* 8:442-453.
- Bernot, M.J., J.L. Tank, T.V. Royer, and M.B. David. 2006. Nutrient uptake in streams draining agricultural catchments of the Midwestern United States. *Freshwater Biology* 51:499-509.
- Bertrand, K.N. 2007. Fishes and floods: Stream ecosystem drivers in the Great Plains. PhD Dissertation, Kansas State University. Manhattan, KS. 141 pp
- Bertrand, K.N., and K.B. Gido. 2007. Effects of the herbivorous minnow, southern redbelly dace (*Phoxinus erythrogaster*) on stream ecosystem structure and function. *Oecologia* 151:69-81.
- Beylea, L.R., and J. Lancaster. 1999. Assembly rules within a contingent ecology. *Oikos* 86:402-416.
- Blair, J.M. 1997. Fire, N availability and plant response in grasslands: A test of the transient maxima hypothesis. *Ecology* 78:2539-2368.
- Blair, J.M., T.R. Seastedt, C.W. Rice, and R.A. Ramundo. 1998. Terrestrial nutrient cycling in tallgrass prairie. Pp. 222-243. In A.K. Knapp, J.M. Briggs, D.C. Hartnett and S.L. Collins (eds.) *Grassland Dynamics: Long-term Ecological Research*. Oxford University Press. New York.

- Blair, J.M., T.C. Todd, and M.A. Callaham Jr. 2000. Responses of grassland soil invertebrates to natural and anthropogenic disturbances. Pages 43-71. In D. C. Coleman and P. F. Hendrix (eds.) *Invertebrates as Webmasters in Ecosystems*. CAB International Press. New York, NY.
- Blaschke, T., and Hay, G.J. 2001. Object-oriented image analysis and scale-space: theory and methods for modeling and evaluating multiscale landscape structure. *International Archives of Photogrammetry and Remote Sensing*, 34, 22-29.
- Bond, W.J., and J.E. Keeley. 2005. Fire as a global 'herbivore': the ecology and evolution of flammable ecosystems. *Trends in Ecology and Evolution* 20:387-394.
- Bond, W.J., F.I. Woodward, and G.F. Midgley. 2005. The global distribution of ecosystems in a world without fire. *New Phytologist* 165:525-538.
- Boutin, S., L. A. Wauters, A. G. McAdam, M. M. Humphries, G. Tosi, and A. Dhondt. 2006. Anticipatory reproduction and population growth in seed predators. *Science* 314:1928-1930.
- Bowman, 2005. Understanding a flammable planet – climate, fire and global vegetation patterns. *New Phytologist* 165:341-345.
- Bradshaw, A.D. 1987. Restoration: An acid test for ecology. Pages 23-29 in W.R. Jordan, M.E. Giplin, and H.J.D. Aber (editors), *Restoration Ecology: A Synthetic Approach to Ecological Restoration*. Cambridge University Press, Cambridge, UK
- Branson, D.H., A. Joern, and G.A. Sword. 2006. Sustainable management of insect herbivores in grassland ecosystems: new perspectives in grasshopper control. *BioScience* 56:743-755.
- Bragg, T.B. 1982. Seasonal variations in fuel and fuel consumption by fires in a bluestem prairie. *Ecology* 63:7-11.
- Bragg, T.B. 1995. The physical environment of Great Plains grasslands. Pages 49-81 in A. Joern and K. H. Keeler (ed.) *The Changing Prairie*. Oxford University Press, Oxford, UK.
- Bragg, T.B., and L.C. Hulbert. 1976. Woody plant invasion of unburned Kansas bluestem prairie. *Journal of Range Management* 29:19-24.
- Briggs, J.M. 1998. Evolution of the Konza Prairie LTER Information Management System. In Michener, William K., John H. Porter, and Susan G. Stafford - Editors. *Data and Information Management in the Ecological Sciences: A Resource Guide*. On line publication <http://www.ecoinformatics.org/pubs/>
- Briggs, J.M., and D.J. Gibson. 1992. Effects of fire on tree spatial patterns in a tallgrass prairie landscape. *Bulletin of Torrey Botanical Club* 119:300-307
- Briggs, J.M., and A.K. Knapp. 1995. Interannual variability in primary production in tallgrass prairie: climate, soil moisture, topographic position and fire as determinants of aboveground biomass. *American Journal of Botany* 82:1024-1030.
- Briggs, J.M., and A.K. Knapp. 2001. Determinants of C₃ forb growth and production in a C₄ dominated grassland. *Plant Ecology* 152:93-100.
- Briggs, J.M., A.K. Knapp, J.M. Blair, J.L. Heisler, G.A. Hoch, M.S. Lett and J.K. McCarron. 2005. An ecosystem in transition: causes and consequences of the conversion of mesic grassland to shrubland. *BioScience* 55:243-254.
- Briggs, J.M., M.D. Nellis, C.L. Turner, G.M. Henebry, and H. Su. 1998. A landscape perspective of patterns and processes in tallgrass prairie. Pages 265-279. In Knapp, A. K., Briggs, J. M., Hartnett, D. C., Collins, S. L. (eds.) *Grassland Dynamics: Long-Term Ecological Research in Tallgrass Prairie*. Oxford University Press. New York.

- Briggs, J.M., T.R. Seastedt, and D.J. Gibson. 1989. Comparative analysis of temporal and spatial variability in above-ground production in a deciduous forest and prairie. *Holarctic Ecology* 12:130-136.
- Briggs, J.M., and H. Su. 1994. Development and refinement of the Konza Prairie LTER Research Information Management Program. Page 87-100. In J. W. Brunt, W. K. Michener and S. Stafford (eds.) *Environmental Information Management and Analysis: Ecosystem to Global Scales*. Taylor and Francis Ltd. London.
- Brockett, B.H., H.C. Biggs, and B. W. van Wilgen. 2001. A patch mosaic burning system for conservation areas in southern African savannas. *International Journal of Wildland Fire* 10:169-183.
- Brown, J.R., and J. Carter. 1998. Spatial and temporal patterns of exotic shrub invasion in an Australian tropical grassland. *Landscape Ecology* 13:93-102.
- Brown, J.H., J.F. Gillooly, A.P. Allen, V.M. Savage, and G.B. West. 2004. Toward a metabolic theory of ecology. *Ecology* 85:1771-1789.
- Brown, J.H., T.J. Valone, and C.G. Curtin. 1997. Reorganization of an arid ecosystem in response to recent climate change. *Proceedings of the National Academy of Science* 94:9729-9733.
- Bryson, R.A., D.A. Baerreis, and W.M. Wendland. 1970. The character of late-glacial and post-glacial climatic changes. Pages 53-74 In W. Dort, Jr. and J.K. Jones, Jr.,(eds.) *Pleistocene and Recent Environments of the Central Great Plains*. University Press of Kansas, Lawrence, KS.
- Burrows, N.D. and G. Wardell-Johnson. 2004. Implementing fire mosaics to promote biodiversity and reduce severity of wildfires in south-western Australian ecosystems. *Proc. 11th AFAC Conf.* Melbourne, Australia.
- Callahan, M.A., Jr., J.M. Blair, T.C. Todd, D.J. Kitchen, and M.R. Whiles. 2003. Effects of fire, mowing and fertilization effects on density and biomass of macroinvertebrates in North American tallgrass prairie soils. *Soil Biology & Biochemistry* 35:1079-1093.
- Callahan, J.T. 1984. Long-term ecological research. *BioScience* 34:363-367.
- Cardinale, B.J., D.S. Srivastava, J.E. Duffy, J.P. Wright, A.L. Downing, M. Sankaran, and C. Jouseau. 2006. Effects of biodiversity on the functioning of trophic groups and ecosystems. *Nature* 433:989-992.
- Chadwick, O.A., P.M. Vitousek, B.J. Heubert, and L.O. Hedin. 1999. Changing sources of nutrients during four million years of ecosystem development: *Nature* 397:491-497.
- Chalcraft, D.R., J.W. Williams, M.D. Smith, and M.R. Willig. 2004. Scale dependence in the relationship between species richness and productivity: the role of spatial and temporal turnover. *Ecology* 85:2701-2708.
- Chapin, F.S.I. 1980. The mineral nutrition of wild plants. *Annual Review of Ecology and Systematics* 11:233-260.
- Chapin, F.S. III, O.E. Sala, and E. Huber-Sannwald. 2001. *Global Biodiversity in a Changing Environment. Scenarios for the 21st Century*. Ecological Studies 152. Springer, New York, NY.
- Christie, J.R., and V.G. Perry. 1951. Removing nematodes from the soil. *Proc. Helminthol. Soc. WA*, 18:106-108.
- Cid, M. S. and M. A. Brizuela. 1998. Heterogeneity in tall fescue pastures created and sustained by cattle grazing. *Journal of Range Management* 51:644-649.
- Clark, C.M., E.E. Cleland, S.L. Collins, J.E. Fargione, L. Gough, S.C. Pennings, K.N. Suding and J.B. Grace. 2007. Environmental and plant community determinants of species loss following nitrogen enrichment. *Ecology Letters* 10:596-607.

- Cleland, E.E., M.D. Smith, S.J. Andelman, C. Bowles, K.M. Carney, M.C. Horner-Devine, J.M. Drake, S.M. Emery, J.M. Gramling, and D.B. Vandermaast. 2004. Invasion in space and time: non-native species richness and relative abundance respond to interannual variation in productivity and diversity. *Ecology Letters* 7:947-957.
- Cohen, W.B., T.K. Maersperger, D.P. Turner, W.D. Ritts, D. Pflugmacher, R.E. Kennedy, A. Kirschbaum, S.W. Running, M. Costa, and S.T. Gower. 2006. MODIS land cover and LAI collection 4 product quality across nine sites in the western hemisphere. *IEEE Transactions in Geosciences and Remote Sensing* 44:1843-1857.
- Cohen, W.B., T.K. Maersperger, Z. Yang, S.T. Gower, D.P. Turner, W.D. Ritts, M. Berterretche, and S.W. Running. 2003. Comparisons of land cover and LAI estimates derived from ETM+ and MODIS for four sites in North America: a quality assessment of 2000/2001 provisional MODIS products. *Remote Sensing of Environment* 88:221-362.
- Coleman, D.C., J.M. Blair, E.T. Elliott and D.H. Wall. 1999. Soil invertebrates. Pages 349-377 In *Standard Soil Methods for Long Term Ecological Research* (G.P. Robertson, C.S. Bledsoe, D.C. Coleman and P. Sollins, eds.) Oxford University Press, New York.
- Collins, S.L. 1992. Fire frequency and community heterogeneity in tallgrass prairie vegetation. *Ecology* 73:2001-2006.
- Collins, S.L. 2000. Disturbance frequency and community stability in native tallgrass prairie. *The American Naturalist* 155:311-325.
- Collins, S.L. 2001. Long-term research and the dynamics of bird populations and communities: An overview. *Auk* 118:583-588.
- Collins, S.L., S.M. Glenn, and J.M. Briggs. 2002. Effect of local and regional processes on plant species richness in tallgrass prairie. *Oikos* 99:571-579.
- Collins, S.L., A.K. Knapp, J.M. Briggs, J.M. Blair, and E.M. Steinauer. 1998. Modulation of diversity by grazing and mowing in native tallgrass prairie. *Science* 280:745-747.
- Collins, S.L., and M.D. Smith. 2006. Scale-dependent interaction of fire and grazing on community heterogeneity in tallgrass prairie. *Ecology* 87:2058-2067.
- Coppedge, B.R., D.M. Engle, C.S. Toepfer, and J.H. Shaw. 1998. Effects of seasonal fire, bison grazing and climatic variation on tallgrass prairie vegetation. *Plant Ecology* 139:235-246.
- Craine, J.M., J. Froehle, D. Tilman, D.A. Wedin, and F.S.I. Chapin. 2001. The relationships among root and leaf traits of 76 grassland species and relative abundance along fertility and disturbance gradients. *Oikos* 93:274-285.
- Craine, J., B. Lee, L. Johnson, W. Bond, and W.D. Williams. 2005. Roots of the world. *Ecology* 86:12-19.
- Crowl, T.A., W.H. McDowell, A.P. Covich, and S.L. Johnson. 2001. Freshwater shrimp effects on detrital processing and nutrients in a tropical headwater stream. *Ecology* 82:775-783.
- Dalgleish, H.J. 2007. Belowground bud banks as regulators of grassland dynamics. PhD Dissertation, Kansas State University. Manhattan, KS. 93 pp.
- Dalgleish, H.J., and D.C. Hartnett. 2006. Belowground bud banks increase along a precipitation gradient of the North American Great Plains: a test of the meristem limitation hypothesis. *New Phytologist* 171:81-89.
- Daly, E., and A. Porporato. 2006. Impact of hydroclimatic fluctuations on the soil water balance. *Water Resources Research* 42: doi:10.1029/2005WR004606.
- Damhoureyeh, S.A., and D.C. Hartnett. 1997. Effects of bison and cattle on growth, reproduction, and abundances of five tallgrass prairie forbs. *American Journal of Botany* 84: 1719-1728.

- Danner, B.J. and A. Joern. 2003. Food-resource mediated impact of predation risk on performance in the grasshopper *Ageneotettix deorum* (Orthoptera). *Oecologia* 137:352-359.
- Danner, B.J. and A. Joern. 2004. Development, growth and egg production of the common grasshopper, *Ageneotettix deorum* (Orthoptera: Acrididae) in response to indirect risk of spider predation. *Ecological Entomology* 29:1-11.
- Danner, B.T., and A.K. Knapp. 2001. Growth dynamics of gallery forest oak seedlings (*Quercus macrocarpa* Michx. and *Quercus muhlenbergii* Engelm.) from gallery forests: implications for forest expansion into grasslands. *Trees* 15:271-277.
- Danner, B.T., and A.K. Knapp. 2003. Abiotic constraints on the establishment of *Quercus* seedlings in grassland. *Global Change Biology* 9:266-275.
- Daubenmire, R. 1968. Ecology of fire in grasslands. *Advances in Ecological Research* 5:209-266.
- Davis, M.A., J.P. Grime, and K. Thompson. 2000. Fluctuating resources in plant communities: a general theory of invasibility. *Journal of Ecology* 88:528- 536.
- Definiens. 2003. "Definiens Imaging, eCognition." Web page, [accessed 3 Jan 2004]. Available at <http://www.definiens.imaging.com>.
- Dell, C.J., and C.W. Rice. 2005. Short-term competition for ammonium and nitrate in tallgrass prairie. *Soil Science Society of America Journal* 69:371-377.
- Dell, C.J., M.A. Williams, and C.W. Rice. 2005. Partitioning of nitrogen over five growing seasons in tallgrass prairie. *Ecology* 86:1280-1287.
- Derry L.A., and O.A. Chadwick. 2007. Contribution from Earth's atmosphere to soil. *Elements* 3:333-338.
- Diamond, J.M. 1975. Assembly of species communities. Pages 342-444 In M. L. Cody & J. M. Diamond (eds.), *Ecology and Evolution of Communities*. Harvard University Press, Cambridge, MA.
- Dodds, W.K. 1997. Distribution of runoff and rivers related to vegetative characteristics, latitude, and slope: A global perspective. *Journal of the North American Benthological Society* 16:162-168.
- Dodds, W. K. 2006. Eutrophication and trophic state in rivers and streams. *Limnology and Oceanography*. 51:671-680.
- Dodds, W.K., J.M. Blair, G.M. Henebry, J.K. Koelliker, R.A. Ramundo, and C.M. Tate. 1996. Nitrogen transport from tallgrass prairie watersheds. *Journal of Environmental Quality* 25:973-981.
- Dodds, W.K., K. Gido, M.R. Whiles, K.M. Fritz, and W.J. Matthews. 2004. Life on the edge: the ecology of Great Plains prairie streams. *BioScience* 54:207-281.
- Dodds, W.K., A.J. López, W.B. Bowden, S. Gregory, N.B. Grimm, S.K. Hamilton, A.E. Hershey, E., Marti, W.B. McDowell, J.L. Meyer, D. Morrall, P.J. Mulholland, B.J. Peterson, J.L. Tank, D.C.J. van der Hoek, J.R. Webster, and W. Wollheim. 2002. N uptake as a function of concentration in streams. *Journal of the North American Benthological Society* 21:206-220.
- Dodds W.K., E. Marti, J.L. Tank, J. Pontius, S.K. Hamilton, N.B. Grimm, W.B. Bowden, W.H. McDowell, B.J. Peterson, H.M. Valett, J.R. Webster, and S. Gregory. 2004. Carbon and nitrogen stoichiometry and nitrogen cycling rates in streams. *Oecologia* 140:458-467.
- Dodds, W.K., and J.A. Nelson. 2006. Redefining the community: a species-based approach. *Oikos* 112:464-472.
- Dodds, W.K. and R.M. Oakes. 2004. A technique for establishing reference nutrient concentrations across watersheds impacted by humans. *Limnology and Oceanography Methods* 2:333-341.
- Dodds, W.K., and R.M. Oakes. 2006. Controls on nutrients across a prairie stream watershed: Land use and riparian cover effects. *Environmental Management* 37:636-646.

- Dodds, W.K., and M.R. Whiles. 2004. Quality and quantity of suspended particles in rivers: Continent-scale patterns in the United States. *Environmental Management* 33:355-367.
- Dukes, J.S., N.R. Chiariello, E.E. Cleland, L.A. Moore, M.R. Shaw, S. Thayer, T. Tobeck, H.A. Mooney, and C.B. Field. Responses of grassland production to single and multiple global environmental changes. *PLOS Biology* doi: 10.1371/journal.pbio.0030319
- Easterling, D.R., G.A. Meehl, C. Parmesan, S.A. Changnon, T.R. Karl and L.O. Mearns. 2000. Climate extremes: observations, modeling, and impacts. *Science* 289: 2068-2074.
- Egerton-Warburton, L.M., N.C. Johnson, and E.B. Allen. 2007. Mycorrhizal community dynamics following nitrogen fertilization: A cross site test in five grasslands. *Ecological Monographs* 77: 527–544.
- Eichmiller, J.J. 2007. Supply, bioavailability, and source of dissolved organic carbon in a prairie stream. Master's thesis, Kansas State University.
- Elser, J.J., M.E.S. Bracken, E.E. Cleland, D.S. Gruner, W.S. Harpole, H. Hillebrnad, J.T. Ngai, E.W. Seabloom, J.B. Shurin, and J.E. Smith. 2007. Global analysis of nitrogen and phosphorus limitation of primary producers in freshwater, marine and terrestrial ecosystems. *Ecology Letters* 10:1135-1142.
- Engle, D.M., and T.G. Bidwell. 2001. Viewpoint: the response of central North American prairies to seasonal fire. *Journal of Range Management* 54:2-10.
- Epstein, H.E., I.C. Burke and W.K. Lauenroth. 2002. Regional patterns of decomposition and primary production rates in the U.S. Great Plains. *Ecology* 83:320-327.
- Evans, E.W., R.A. Rogers, and D.J. Opfermann. 1983. Sampling grasshoppers (Orthoptera: Acridide) on burned and unburned tallgrass prairie: night trapping vs. sweeping. *Environmental Entomology* 12:1449-1454.
- Fahey, T.J. and A.K. Knapp 2007. Principles and Standards for Measuring Net Primary Production. Oxford University Press, NY, 268 pages.
- Fay, P.A. 2003. Insect diversity in two burned and grazed grasslands. *Environmental Entomology* 32:1099-1104.
- Fay, P.A., J.D. Carlisle, A.K. Knapp, J.M. Blair, and S.L. Collins. 2000. Altering rainfall timing and quantity in a mesic grassland ecosystem: Design and performance of rainfall manipulation shelters. *Ecosystems* 3:308-319.
- Fay, P.A., J.D. Carlisle, A.K. Knapp, J.M. Blair, and S.L. Collins. 2003. Productivity responses to altered rainfall patterns in a C4-dominated grassland. *Oecologia* 137:245-251.
- Ferwerda, J., A.K. Skidmore, and O. Mutanga. 2005. Nitrogen detection with hyperspectral normalized ratio indices across multiple plant species. *International Journal of Remote Sensing* 18:4083-4095.
- Ferwerda, J., A.K. Skidmore, and A. Stein. 2006. A bootstrap procedure to select hyperspectral wavebands related to tannin content. *International Journal of Remote Sensing* 27:1413-1424.
- Fieberg, J., and S. P. Ellner. 2001. Stochastic matrix models for conservation and management: a comparative review of methods. *Ecology Letters* 4:244-266.
- Foster, D., F. Swanson, J., Aber, I. Burke, N. Brokaw, D. Tilman, and A. Knapp. 2003. The importance of land-use legacies to ecology and conservation. *BioScience* 53:77-88.
- Frank, D.A. 2005. The interactive effects of grazing ungulates and aboveground production on grassland diversity. *Oecologia* 143:629-634.

- Frank, D.A. 2007. Drought effects on above- and belowground production of a grazed temperate grassland ecosystem. *Oecologia* 152:131-139.
- Frank, D.A. and R.D. Evans. 1997. Effects of native grazers on grassland N cycling in Yellowstone National Park. *Ecology* 78:2238-2248
- Franssen, N.R., K.B. Gido, T.R. Strakosh, K.N. Bertrand, C.M. Franssen, C.P. Paukert, K.L. Pitts, C.S. Guy, J.A. Tripe, and S.J. Shrank. 2006. Effects of floods on fish assemblages in an intermittent prairie stream. *Freshwater Biology* 51:2072-2086.
- Freeman, C.C. 1998. The flora of Konza Prairie: A historical review and contemporary patterns, p. 69–80. In: A. K. Knapp, J. M. Briggs, D. C. Hartnett and S. L. Collins (eds.). *Grassland dynamics: long-term ecological research in tallgrass prairie*. Oxford University Press, New York.
- Fuhlehdorf, S.D., and D.M. Engle. 2001. Restoring heterogeneity on rangelands: ecosystem management based on evolutionary grazing patterns. *BioScience* 51:625-632.
- Fuhlendorf, S.D., and D.M. Engle. 2004. Application of the fire-grazing interaction to restore a shifting mosaic on tallgrass prairie. *Journal of Applied Ecology* 41:603-614.
- Fuhlendorf, S.D., W.C. Harrell, R.G. Hamilton, C.A. Davis, and D.M. Leslie, Jr. 2006. Should heterogeneity be the basis for conservation? Grassland bird response to fire and grazing. *Ecological Applications* 16:1706-1716.
- Garrett, K.A., S.P. Dendy, E.E. Frank, M.N. Rouse, and S.E. Travers. 2006. Climate change effects on plant disease: from genes to ecosystems. *Annual Review of Phytopathology* 44:489-509.
- Gerlanc, N.M. 2004. Bison wallows: community assembly and population dynamics in isolated ephemeral aquatic habitats of the tallgrass prairie. PhD dissertation, Kansas State University.
- Gibson, D.J. 1988. Regeneration and fluctuations of tallgrass prairie vegetation in response to burning frequency. *Bulletin of the Torrey Botanical Club* 115: 1-12.
- Gill, A.M., G. Allan, and C. Yates. 2003. Fire-created patchiness in Australian savannas. *Inter. J. Wildland Fire* 12: 323-331.
- Gilliam, F.S. 1987. The chemistry of wet deposition for a tallgrass prairie ecosystem: inputs and interactions with plant canopies. *Biogeochemistry* 4:203-217.
- Gillooly, J.F., J.H. Brown, G.B. West, V.M. Savage, and E. Charnov. 2001. Effects of size and temperature on metabolic rate. *Science* 292:2248-2251.
- Gleason, H.A. 1913. The relation of forest distribution and prairie fires in the middle west. *Torrey* 173-181.
- Goossens, D. 2007. Bias in grain size distribution of deposited atmospheric dust due to the collection of particles in sediment catchers. *Catena* 70:16-24.
- Goossens, D. 2000. Dry aeolian dust accumulation in rocky deserts, a medium-term field experiment based on short-term wind-tunnel simulations. *Earth Surface Processes and Landforms* 25:41-57.
- Gorentz, J., G. Koerper, M. Marozas, S. Weiss, P. Alaback, M. Farrell, M. Dyer and G.R. Marzolf. 1983. Data management at biological field stations. Report of a workshop at W. K. Kellogg Biological Station, Michigan State University, May 17-20, 1982. Prepared for the National Science Foundation.
- Gould, W. R., and J. D. Nichols. 1998. Estimation of temporal variability of survival in animal populations. *Ecology* 79:2531-2538.
- Grace, J.B. 2007. *Structural Equation Modeling and Natural Systems*. Cambridge University Press, Cambridge, UK.

- Grace, J.B., T.M. Anderson, M.D. Smith, E. Seabloom, S.J. Andelman, G. Meche, E. Weiher, L.K. Allain, H. Jutila, M. Sankaran, J. Knops, M. Ritchie, and M.R. Willig. 2007. Does species diversity limit productivity in natural grassland communities? *Ecology Letters* 10:680-689.
- Greenland, D., D.G. Goodin, and R.C. Smith. 2003. *Climate Variability and Ecosystem Response at Long-Term Ecological Research sites*. Oxford University Press, New York. 459 pages.
- Gregory, J.M., J.F.B. Mitchell and A.J. Brady. 1997. Summer drought in northern mid-latitudes in a time-dependent CO₂ climate experiment. *Journal of Climate* 10:662-686.
- Groisman, P. Y., T.R. Karl, D.A. Easterling, R.W. Knight, P.F. Jamason, K.J. Hennessy, R. Suppiah, C.M. Page, J. Wibig, K. Fortuniak, V.N. Razuvaev, A. Douglas, E. Forland, and P. Zhai. 1999. Changes in the probability of heavy precipitation: important indicators of climatic change. *Climatic Change* 42: 243-283.
- Grousset F.E., and P.E. Biscaye. 2005. Tracing dust sources and transport patterns using Sr, Nd and Pb isotopes. *Chemical Geology* 222:149-167.
- Gurtz, M. E. 1986. Development of research data management system: factors to consider. Page 23-38. In W. K. Michener (eds.) *Research Data Management in the Ecological Science*. University of South Carolina Press, Belle Baruch Marine Library No. 16. Columbia, SC.
- Harper, C.W., J.M. Blair, P.A. Fay, A.K. Knapp, and J.D. Carlisle. 2005. Increased rainfall variability and reduced rainfall amount decreases soil CO₂ flux in a grassland ecosystem. *Global Change Biology* 11:322-344.
- Harper, S. 2003. *Pollination and floral scent biology of Phlox divaricata L. (Polemoniaceae)*. MS Thesis, Kansas State University. Manhattan, KS. 66 pp
- Harpole, W.S., and D. Tilman. 2006. Non-neutral patterns of species abundance in grassland communities. *Ecology Letters* 9:15-23.
- Harrington, R., I. Woiwood, and T. Sparks. 1999. Climate change and trophic interactions. *Trends in Ecology and Evolution* 14:146-150.
- Harris, J.A., R.J. Hobbs, E. Higgs, and J. Aronson. 2006. Ecological restoration and global climate change. *Restoration Ecology* 14:170-176.
- Hartnett, D.C., K.R. Hickman, and L.E.F. Walter. 1996. Effects of bison grazing, fire and topography on floristic diversity in tallgrass prairie. *Journal of Range Management* 49: 413-420.
- Hartnett, D.C., and K.H. Keeler. 1995. Population Processes. Page 82-99. In A. Joern and K. K. Keeler (eds.) *The Changing Prairie*. Oxford University Press. Oxford.
- Hartnett, D.C., A.L.F. Potgieter, and G.W.T. Wilson. 2004. Fire effects on mycorrhizal symbiosis and root system architecture in southern African savanna grasses. *African Journal of Ecology* 42:1-10.
- Hartnett, D.C., and F.H.M. Semazzi. 2006. *Enhancing collaborative research on the environment in sub-Saharan Africa*. OISE National Science Foundation Report. 99 pp
- Hartnett, D.C., M.P. Setshogo, and H.J. Dalglish. 2006. Bud banks of perennial savanna grasses in Botswana. *African Journal of Ecology* 44:256-263.
- Hartnett, D.C., and G.W.T. Wilson. 1999. Mycorrhizae influence plant community structure and diversity in tallgrass prairie. *Ecology* 80:1187-1195.
- Hartnett, D.C., and G.T. Wilson. 2002. The role of mycorrhizas in plant community structure and dynamics: lessons from grasslands. *Plant and Soil* 244:319-331.

- Hayden, B.P. 1998. Regional climate and the distribution of tallgrass prairie. Pages 19-34 in A.K. Knapp, J.M. Briggs, D.C. Hartnett, and S.L. Collins, (eds.) *Grassland Dynamics: Long-Term Ecological Research in Tallgrass Prairie*. Oxford University Press. New York
- Heatherly, T., M.R. Whiles, D.J. Gibson, S.L. Collins, A.D. Huryn, J.K. Jackson, and M.A. Palmer. 2007. Stream insect occupancy-frequency patterns and metapopulation structure. *Oecologia* 151:313-321.
- Heisler, J.L., J.M. Briggs, and A.K. Knapp. 2003. Long-term patterns of shrub expansion in a C₄-dominated grassland: fire frequency and the dynamics of shrub cover and abundance. *American Journal of Botany* 90:423-428.
- Heisler, J.L., J.M. Briggs, A.K. Knapp, J.M. Blair, and A. Seery. 2004. Direct and indirect effects of fire on shrub density and aboveground productivity in a mesic grassland. *Ecology* 85:2245-2257.
- Helgason T., T.J. Daniell, R. Husband, A.H. Fitter, and J.P.W. Young. 1998. Ploughing up the wood-wide web? *Nature* 394:431.
- Hendry, M.J., and L.I. Wassenaar. 2004. Transport and chemical controls on the distribution of solutes and stable isotopes in a thick clay-rich till aquitard, Canada. *Isotopes in Environmental and Health Studies* 40:3-19.
- Herrera, C.M. 1998. Population-level estimates of interannual variability in seed production: what do they actually tell us? *Oikos* 82:612-616.
- Hetrick, B.A.D., D.C. Hartnett, G.W.T. Wilson, and D.J. Gibson. 1994. Effects of mycorrhizal and plant density on yield relationships among competing tallgrass prairie grasses. *Canadian Journal of Botany* 72:168-176.
- Hickman, K.R., D.C. Hartnett, R.C. Cochran, and C.E. Owensby. 2004. Grazing management effects on plant species diversity in tallgrass prairie. *Journal of Range Management* 57:58-65.
- Hobbs, R.J., and J.A. Harris. 2001. Restoration ecology: repairing the Earth's ecosystems in the new millennium. *Restoration Ecology* 9:209-219.
- Hobbs, R.J., and D.A. Norton. 2004. Ecological filters, thresholds, and gradients in resistance to ecosystem reassembly. Pages 72-95 in V.M. Temperton, R.J. Hobbs, T. Nuttle and S. Halle (eds.), *Assembly Rules and Restoration Ecology*. Island Press, Washington D.C., USA.
- Hobbs, N.T. 1996. Modification of ecosystems by ungulates. *Journal of Wildlife Management* 60:695-713.
- Hobbs, N.T., D.S. Schimel, C.E. Owensby, and D.J. Ojima. 1991. Fire and grazing in tallgrass prairie: contingent effects on nitrogen budgets. *Ecology* 72:1374-1382.
- Hoch, G.A., J.M. Briggs, and L.C. Johnson. 2002. Assessing the rate, mechanism and consequences of conversion of tallgrass prairie to *Juniperus virginiana* forest. *Ecosystems* 5:578-586.
- Holmes C.W., and R. Miller. 2004. Atmospherically transported elements and deposition in the southeastern United States: local or transoceanic? *Applied Geochemistry* 19:1189-1200.
- Hooper D.U., F.S. Chapin, J.J. Ewel, A. Hector, P. Inchausti, S. Lavorel, J.H. Lawton, D.M. Lodge, M. Loreau, S. Naeem, B. Schmid, H. Setälä, A.J. Symstad, J. Vandermeer, and D.A. Wardle. 2005. Effects of biodiversity on ecosystem functioning: A consensus of current knowledge. *Ecological Monographs* 75:3-35.
- Howe, H.F., and J.S. Brown. 1999. Effects of birds and rodents on synthetic tallgrass communities. *Ecology* 80:1776-1781.
- Howe, H.F., J.S. Brown, and B. Zorn-Arnold. 2002. A rodent plague on prairie diversity. *Ecology Letters* 5:30-36.

- Howe, H.F., and D. Lane. 2004. Vole-driven succession in experimental wet-prairie restorations. *Ecological Applications* 14:1295-1305.
- Houlahan, J.E., D.J. Currie, K. Cottenie, G.S. Cumming, S.K.M. Ernest, C.S. Findlay, S.D. Fuhlendorf, U. Gaedke, P. Legendre, J.J. Magnuson, B.H. McArdle, E.H. Muldavin, D. Noble, R. Russell, R.D. Stevens, T.J. Willis, I.P. Woiwod and S.M. Wondzell. 2007. Compensatory dynamics are rare in natural ecological communities. *Proceedings of the National Academy of Sciences* 104:3273-3277.
- Hulbert, L.C. 1988. Causes of fire effects in tallgrass prairie. *Ecology* 69:46-58.
- Huxman, T.E., M.D. Smith, P.A. Fay, A.K. Knapp, M.R. Shaw, M.E. Loik, S.D. Smith, D.T. Tissue, J.C. Zak, J.F. Weltzin, W.T. Pockman, O.E. Sala, B.M. Haddad, J. Harte, G.W. Koch, S. Schwinning, E.E. Small, and D.G. Williams. 2004. Convergence across biomes to a common rain-use efficiency. *Nature* 429:651-654.
- Intergovernmental Panel on Climate Change (IPCC). 2007. *Climate Change 2007: Synthesis Report, Fourth Assessment Report of the Intergovernmental Panel on Climate Change.*
- Jastrow, J.D., R.M. Miller, and J. Lussenhop. 1998. Contributions of interacting biological mechanisms to soil aggregate stabilization in restored prairie. *Soil Biology and Biochemistry* 30:905-916.
- Joern, A. 2004. Variability in grasshopper densities in response to fire frequency and bison grazing from tallgrass prairie. *Environmental Entomology* 33:1617-1625.
- Joern, A. 2005. Disturbance by fire frequency and bison grazing modulate grasshopper species assemblages (Orthoptera) in tallgrass prairie. *Ecology* 86:861-873.
- Johnson, L.C., and J.R. Matchett. 2001. Fire and grazing regulate belowground processes in tallgrass prairie. *Ecology* 82:3377-3389.
- Johnson, N.C., J.H. Graham, and F.A. Smith. 1997. Functioning of mycorrhizal associations along the mutualism-parasitism continuum. *New Phytologist* 135:575-585.
- Johnson, N.C., D.L. Rowland, L. Corkidi, L.M. Egerton-Warburton, and E.B. Allen. 2003. Nitrogen enrichment alters mycorrhizal allocation at five mesic to semiarid grasslands. *Ecology* 84:1895-1908.
- Jonas, J.L., and A. Joern. 2007. Grasshopper (Orthoptera: Acrididae) communities respond to fire, bison grazing and weather in North American tallgrass prairie: a long-term study. *Oecologia* 153:699-711.
- Jonas, J.L., G.W.T. Wilson, P.M. White, and A. Joern. 2007. Consumption of mycorrhizal and saprophytic fungi by Collembola in grassland soils. *Soil Biology & Biochemistry* 39:2594-2602.
- Jones, K.L., T.C. Todd, J.L. Wall-Beam, J.D. Coolon, J.M. Blair, and M.A. Herman. 2006. Molecular approach for assessing responses of microbial-feeding nematodes to burning and chronic nitrogen enrichment in a native grassland. *Molecular Ecology* 15:2601-2609.
- Jumpponen, A., J. Trowbridge, K.G. Mandyam, and L.C. Johnson. 2005. Nitrogen enrichment causes minimal changes in arbuscular mycorrhizal colonization but shifts community composition - evidence from rDNA data. *Biology and Fertility of Soils* 41:217-224.
- Kaufman, D.W., and S.H. Bixler. 1995. Prairie voles impact plants in tallgrass prairie. Pages 117-121. In D.C. Hartnett (ed.) *Prairie Diversity*. Proceedings of the 14th Annual North American Prairie Conference, Kansas State University, Manhattan.
- Kaufman, D.W., G. A. Kaufman, P.A. Fay, J.L. Zimmerman, and E.W. Evans. 1998. Animal populations and communities. Pages 113-139. In A.K. Knapp, J.M. Briggs, D.C. Hartnett and S.L. Collins (eds.) *Grassland Dynamics: Long-Term Ecological Research in Tallgrass Prairie*. Oxford University Press. New York.

- Kaufman, G.A. 1990. Population ecology, social organization, and mating systems in the deer mouse (*Peromyscus maniculatus bairdii*) in mixed grass prairie. Dissertation, Kansas State University, Manhattan. 187 pp.
- Kaufman, G.A. and D.W. Kaufman. 1989. An artificial burrow for the study of natural populations of small mammals. *Journal of Mammalogy* 70:656-659.
- Kaufman, G.A. and D.W. Kaufman. 1997. Ecology of small mammals in prairie landscapes. Pages 207-243. In F.L. Knopf and F.B. Samson (eds.) *Ecology and Conservation of Great Plains Vertebrates*. Springer-Verlag, New York.
- Keddy, P. 1992. Assembly and response rules: two goals for predictive community ecology. *Journal of Vegetation Science* 3:157-164.
- Kemp, M.J. 2001. Factors controlling spatial and temporal patterns of nitrogen cycling in tallgrass prairie streams. PhD dissertation, Kansas State University.
- Kemp, M.J., and W.K. Dodds. 2001. Spatial and temporal patterns of nitrogen concentrations in pristine and agriculturally- influenced prairie streams. *Biogeochemistry* 53:125-141.
- Kindscher, K., and L.L. Tieszen. 1998. Floristic and soil organic matter changes after five and twenty-five years of native tallgrass prairie restoration. *Restoration Ecology* 6:181-196.
- Kingsolver, R. W. 1986. Vegetative reproduction as a stabilizing feature of the population dynamics of *Yucca glauca*. *Oecologia*. 69: 380-387.
- Kissing, K.R., and G.L. Macpherson. 2006. Short-term water-level fluctuations and long-term water-level decline at the Konza Prairie - drought or vegetation? *Geological Society of America Abstracts* 38: 35.
- Knapp, A.K. 1984. Water relations and growth of three grasses during wet and drought years in a tallgrass prairie. *Oecologia* 65:35-43.
- Knapp, A.K., J.M. Blair, J.M. Briggs, S.L. Collins, D.C. Hartnett, L.C. Johnson, and E.G. Towne. 1999. The keystone role of bison in North American tallgrass prairie. *BioScience* 49:39-50.
- Knapp, A.K., J.M. Briggs, S.L. Collins, S.R. Archer, M.S. Bret-Harte, B.E. Ewers, D.P. Peters, D.R. Young, G.R. Shaver, E. Pendall, and M.B. Cleary. 2008. Shrub encroachment in North American grasslands: Shifts in growth form dominance rapidly alters control of ecosystem carbon inputs. *Global Change Biology* 14:615-623.
- Knapp, A.K., J.M. Briggs, D.C. Hartnett, and S.L. Collins (eds.). 1998. *Grassland Dynamics: Long-Term Ecological Research in Tallgrass Prairie*. Oxford University Press, New York. 364 pages.
- Knapp, A.K., J.M. Briggs and J.K. Koelliker. 2001. Frequency and extent of water limitation to primary production in a mesic temperate grassland. *Ecosystems* 4:19-28.
- Knapp, A.K., C.E. Burns, R.W.S. Fynn, K.P. Kirkman, C.D. Morris, and M.D. Smith. 2006. Convergence and contingency in production-precipitation relationships in North American and South African C₄ grasslands. *Oecologia* 149:456-464
- Knapp, A.K., J.T. Fahnestock, S.P. Hamburg, L.J. Statland, T.R. Seastedt, and D.S. Schimel. 1993. Landscape patterns in soil-water relations and primary production in tallgrass prairie. *Ecology* 74: 549-560.
- Knapp A.K., P.A. Fay, S.L. Collins, M.D. Smith, J.D. Carlisle, C.W. Harper, B.T. Danner, M.S. Lett, and J.K. McCarron. 2002. Rainfall variability, carbon cycling, and plant species diversity in a mesic grassland. *Science* 298:2202-2205.

- Knapp, A.K., M.D. Smith, S.L. Collins, N. Zambatis, M. Peel, S. Emery, J. Wojdak, M.C. Horner-Devine, H. Biggs, J. Kruger and S.J. Andelman. 2004. Generality in ecology: testing North American grassland rules in South African savannas. *Frontiers in Ecology and the Environment* 9:483-491
- Knapp A.K., J.K. McCarron, A.M. Silletti, G.A. Hoch, J.L. Heisler, M.S. Lett, J.M. Blair, J.M. Briggs, and M.D. Smith. 2008. Ecological consequences of the replacement of native grassland by *Juniperus virginiana* and other woody plants. Pages 156-169 In O.W. Van Auken (ed.) *Western North American Juniperus Communities: A Dynamic Vegetation Type*. Springer Ecological Studies #196, Springer-Verlag.
- Knapp, A.K., and T.R. Seastedt. 1986. Detritus accumulation limits productivity of tallgrass prairie. *BioScience* 36:662-668.
- Knapp, A.K., and M.D. Smith. 2001. Variation among biomes in temporal dynamics of aboveground primary production. *Science* 291:481-484.
- Knight, C.L., J.M. Briggs, and M.D. Nellis. 1994. Expansion of gallery forest on Konza Prairie Research Natural Area, Kansas, USA. *Landscape Ecology* 9:117-125.
- Knight, G.L., and K.B. Gido. 2005. Habitat use and susceptibility to predation of four prairie stream fishes: implications for conservation of the endangered Topeka shiner. *Copeia* 1:38-47.
- Koenig, W.D., D. Kelly, V.L. Sork, R.P. Duncan, J.S. Elkinton, M.S. Peltonen, and R.D. Westfall. 2003. Dissecting components of population-level variation in seed production and the evolution of masting behavior. *Oikos* 102:581-591.
- Koenig, W.D., R.L. Mumme, W.J. Carmen, and M.T. Stanback. 1994. Acorn production by oaks in central coastal California: variation within and among years. *Ecology* 75:99-109.
- Koenig, W. D. and Knops, J. M. H. 2005. The mystery of masting in trees. Some trees reproduce synchronously over large areas, with widespread ecological effects, but how and why? *American Scientist* 93:340-347.
- Kosciuch, K.L., T.H. Parker, and B.K. Sandercock. 2006. Nest desertion by a cowbird host: an antiparasite behavior or a response to egg loss? *Behavioral Ecology* 17:917-924.
- Kosciuch, K.L., J.W. Rivers, and B.K. Sandercock. *in press*. Stable isotopes identify the natal origins of a generalist brood parasite. *Journal of Avian Biology*.
- Kosciuch, K.L., and B.K. Sandercock. *in press*. Experimental removal of Brown-headed Cowbirds increases productivity of the parasite and their songbird host. *Ecological Applications*.
- Kula, A.R., D.C. Hartnett, and G.W.T. Wilson. 2005. Mycorrhizal symbiosis and insect herbivory in tallgrass prairie microcosms. *Ecology Letters* 81:61-69.
- Kula, R.R., and G. Zolnerowich. *In press*. Revision of New World *Chaenusa* Haliday sensu lato (Hymenoptera: Braconidae: Alysiinae), with new species, synonymies, hosts, and distribution records. *Proceedings of the Entomological Society of Washington* 110: 1-60.
- Kula, R.R., G. Zolnerowich, and C. J. Ferguson. 2006. Phylogenetic analysis of *Chaenusa* sensu lato (Hymenoptera: Braconidae) using mitochondrial NADH 1 dehydrogenase gene sequences. *Journal of Hymenoptera Research* 15: 251-265.
- Kula, R.R., and G. Zolnerowich. 2005. A new species of *Epimicta* Förster (Hymenoptera: Braconidae) from North America and new distribution records for *Epimicta griffithsi*. *Proceedings of the Entomological Society of Washington* 107: 78-83.
- Laliberte, A.S, A. Rango, K.M. Havstad, J.F. Paris, R.F. Beck, R. McNeeley, and A.L. Gonzalea. 2004. Object-oriented image analysis for mapping shrub densities from 1937 to 2003 in southern New Mexico. *Remote Sensing of Environment* 93: 198-210.

- Lane, D.R., and H. BassiRad. 2002. Differential responses of tallgrass prairie species to nitrogen loading and varying ratios of NO_3^- to NH_4^+ . *Functional Plant Biology* 29:1227-1235.
- Lauenroth, W.K, I.C. Burke, and M.P. Gutman. 1999. The structure and function of ecosystems in the central North American grassland region. *Great Plains Research* 9:223-259.
- Lemaire, G., J. Hodgson, A. de Moraes, P.C. de F. Carvalho, and C. Nabinger (eds.). 2000. *Grassland Ecophysiology and Grazing Ecology*. CAB International, Wallingford, UK.
- Lett, M.S., A.K. Knapp, J.M. Briggs, and J.M. Blair. 2004. Influence of shrub encroachment on aboveground net primary productivity and carbon and nitrogen pools in a mesic grassland. *Canadian Journal of Botany* 82:1363-1370.
- Lima, S.L. and P.A. Zollner. 1996. Towards a behavioural ecology of ecological landscapes. *Trends in Ecology & Evolution* 11:131-135.
- Liu, J., T. Dietz, S.R. Carpenter, M. Alberti, C. Folke, E. Moran, A.N. Pell, P. Deadman, T. Kratz, J. Luchenco, E. Ostrom, Z. Ouyang, W. Provencher, C.L. Redman, S.H. Schneider and W.W. Taylor. 2007. Complexity of coupled human and natural systems. *Science* 317:1513-1516.
- Lockwood, J.L., R.D. Powell, M.P. Nott, and S.L. Pimm. 1997. Assembling ecological communities in time and space. *Oikos* 80:549-553.
- Lockwood, J. L., and C.L. Samuels. 2004. Assembly models and the practice of restoration. Pages 55-70 in V.M. Temperton, R.J. Hobbs, T. Nuttle, and S. Halle (eds.), *Assembly Rules and Restoration Ecology*. Island Press, Washington D.C.
- Lubchenco, J. 1998. Entering the century of the environment: a new social contract for science. *Science* 279:491-497.
- Luo, Y., S. Wan, D. Hui, and L.L. Wallace. 2001. Acclimation to soil respiration to warming in a tallgrass prairie. *Nature* 413:622-625.
- Macpherson, G.L. 1996. Hydrogeology of thin-bedded limestones: the Konza Prairie Long-Term Ecological Research site, Northeastern Kansas. *Journal of Hydrology* **186**: 191-228.
- Macpherson, G.L., W.C. Johnson, and L.W. Gatto. 2005. REE in Konza Prairie LTER Site (USA) soil - allochthonous?: *Geochimica et Cosmochimica Acta* 69):A604.
- Macpherson G.L., J.A. Roberts, J.M. Blair, M.A. Townsend, D.A. Fowle, and K.R. Beisner. In review. Increasing shallow groundwater CO_2 and chemical weathering, Konza Prairie, USA: *Geochimica et Cosmochimica Acta*.
- Macpherson, G. L., J. A. Roberts, and D.A. Fowle, 2006, Increasing Groundwater CO_2 and Other Solutes Under Tallgrass Prairie, Northeastern Kansas, USA: *Eos Trans. AGU*, 87(52), Fall Meet. Suppl., Abstract V53D-1786.
- Macpherson, G.L., and M. Sophocleous. 2004. Fast ground-water mixing and basal recharge in an unconfined, alluvial aquifer, Konza LTER Site, Northeastern Kansas. *Journal of Hydrology* 286:271-299.
- Maina, G.G. and H.F. Howe. 2000. Inherent rarity in community restoration. *Conservation Biology* 14:1335-1340.
- Margulies, M., M. Egholm, W.E. Altman *et al.* 2005. Genome sequencing in microfabricated high-density picolitre reactors. *Nature* 437:376-380.
- Martin, L.M., K.A. Moloney, and B.J. Wilsey. 2005. An assessment of grassland restoration success using species diversity. *Journal of Applied Ecology* 42:327-336.

- Martinez-Garza, C., S. Saha, V. Torres, J.S. Brown, and H.F. Howe. 2004. Planting densities and bird and rodent absence affect size distributions of four dicots in synthetic tallgrass communities. *Oecologia* 139:433-439.
- Matlack, R.S., D.W. Kaufman, and G.A. Kaufman. *In press*. Influence of woody vegetation on small mammals in tallgrass prairie. *American Midland Naturalist*.
- Matlack, R.S., D.W. Kaufman, G.A. Kaufman, and B.R. McMillan. 2002. Long-term variation in abundance of Elliot's short-tailed shrew (*Blarina hylophaga*) in tallgrass prairie. *Journal of Mammalogy* 83:280-289.
- Matthews, W.J., K.B. Gido, G.P. Garrett, F.P. Gelwick, J. Stewart, and J. Schaefer. 2006. Modular experimental riffle-pool stream system. *Transactions of the American Fisheries Society* 135:1559-1566.
- Mason, J.A., and P.M. Jacobs. 1998. Chemical and particle-size evidence for addition of fine dust to soils of the midwestern United States. *Geology* 26:1135-1138.
- McAllister, C.A., A.K. Knapp, and L.A. Maragni. 1998. Is leaf-level photosynthesis related to plant success in a highly productive grassland? *Oecologia* 117:40-46.
- McCulley, R.L., I.C. Burke, J.A. Nelson, W.K. Lauenroth, A.K. Knapp, and E.F. Kelly. 2005. Regional patterns in carbon cycling across the Great Plains of North America. *Ecosystems* 8:106-121.
- McGill . B.J., B.J. Enquist, E. Weiher, and M. Westoby. 2006. Rebuilding community ecology from functional traits. *Trends in Ecology and Evolution* 21:178-185.
- McGonigle, T.P., M.H. Miller, D.G. Evans, G.L. Fairchild, and J.A. Swan. 1990. A new method which gives an objective measure of colonization of roots by vesicular-arbuscular mycorrhizal fungi. *New Phytologist* 115:495-501.
- McKinley, D.C., M.D. Norris, L.C. Johnson, and J.M. Blair. 2008. Biogeochemical changes associated with *Juniperus virginiana* encroachment into grasslands. Pages 170-187 In O.W. Van Auken (ed.) *Western North American Juniperus Communities: A Dynamic Vegetation Type*. Springer Ecological Studies #196, Springer-Verlag
- McLauchlan, K.K., J. M. Craine, W.W. Oswald, P.R. Leavitt, and G.E. Likens. 2007. Changes in nitrogen cycling during the past century in a northern hardwood forest. *Proceedings of the National Academy of Sciences* 104:7466-7470.
- McLauchlan, K.K., S.E. Hobbie, and W.M. Post. 2006. Conversion from agriculture to grassland builds soil organic matter on decadal time scales. *Ecological Applications* 16:143-153.
- McNaughton, S.J. 2001. Herbivory and trophic interactions. Pages 101-122 in, J. Roy, B. Saugier, and H. A. Mooney, (eds.) *Terrestrial Global Productivity: Past, Present, Future*. Academic Press, San Diego.
- McNaughton, S.J., D. Milchunas, and D.A. Frank. 1996. How can net primary productivity be measured in grazing ecosystems? *Ecology* 77:974-977.
- Meyer, C.K., M.R. Whiles, and R.E. Charlton. 2002. Life history, secondary production, and ecosystem significance of acridid grasshoppers in annually burned and unburned tallgrass prairie. *American Entomologist* 48:40-49.
- Mikha M.M, and C.W. Rice. 2004. Tillage and manure effects on soil and aggregate-associated carbon and nitrogen. *Soil Science Society of America Journal* 68: 809-816.
- Miller, R.M., D.R. Reinhardt, and J.D. Jastrow. 1995. External hyphal production of vesicular-arbuscular mycorrhizal fungi in pasture and tallgrass prairie communities. *Oecologia* 103:17-23.

- Moleele, N.M., and J.S. Perkins. 1998. Encroaching woody plant species diversity and boreholes: Is cattle density the main driving factor in the Olifants Drift communal grazing lands, south-east Botswana? *Journal of Arid Environment* 40:245–253.
- Mong, T.W. 2005. Using radio-telemetry to determine range and resource requirements of Upland Sandpipers at an experimentally managed prairie landscape. MSc Thesis. Kansas State University, Manhattan, Kansas.
- Mong, T. W., and B. K. Sandercock. 2007. Optimizing radio retention and minimizing radio impacts in a field study of Upland Sandpipers. *Journal of Wildlife Management* 71:971-980.
- Muhs, D.R., and E.A. Bettis. 2001. Impact of climate and parent material on chemical weathering in loess-derived soils of the Mississippi River valley. *Soil Science Society of America Journal* 65:1761-1777.
- Mulholland, P.J., J.L. Tank, J.R. Webster, W.B. Bowden, W.K. Dodds, S.V. Gregory, N.B. Grimm, S.K. Hamilton, S.L. Johnson, E. Marti, W.H. McDowell, J. Merriam, J.L. Meyer, B.J. Peterson, H.M. Valett, and W.M. Wollheim. 2002. Can uptake length in streams be determined by nutrient addition experiments? Results from an inter-biome comparison study. *Journal of the North American Benthological Society* 21:544-560.
- Mulholland, P.J., A.M. Helton, G.C. Poole, R.O. Hall, Jr., S.K. Hamilton, B.J. Peterson, J.L. Tank, L.R. Ashkenas, L.W. Cooper, C.N. Dahm, W.K. Dodds, S. Findlay, S.V. Gregory, N.B. Grimm, S.L. Johnson, W.H. McDowell, J.L. Meyer, H.M. Valett, J.R. Webster, C. Arango, J.J. Beaulieu, M.J. Bernot, A.J. Burgin, C. Crenshaw, L. Johnson, B.R. Niederlehner, J.M. O'Brien, J.D. Potter, R.W. Sheibley, D.J. Sobota, and S.M. Thomas. (*In press*) Excess nitrate from agricultural and urban areas reduces denitrification efficiency in streams. *Nature*
- Murdock, J.N., and W.K. Dodds. 2007. Linking benthic algal biomass to stream substratum topography. *Journal of Phycology* 43:449-460.
- Mutanga, O. and D. Rugege. 2006. Integrating remote sensing and spatial statistics to model herbaceous biomass distribution in a tropical savanna. *International Journal of Remote Sensing* 27:3499-3514.
- Mutanga, O. and A.K. Skidmore. 2004a. Discriminating sodium concentration in a mixed grass species environment of the Kruger National Park using field spectrometry. *International Journal of Remote Sensing* 20:4191-4201.
- Mutanga, O. and A.K. Skidmore. 2004b. Integrating imaging spectroscopy and neural networks to map grass quality in Kruger National Park, South Africa. *Remote Sensing of Environment* 90:104-115.
- Mutanga, O., A.K. Skidmore, L. Kumamr, and J. Ferwerda. 2005. Estimating tropical pasture quality at canopy level using band depth analysis with continuum removal in the visible domain. *International Journal of Remote Sensing* 26:1093-1108.
- Mutanga, O., A.K. Skidmore, and H.H.T. Prins. 2004. Predicting *in situ* pasture quality in the Kruger National Park, South Africa, using continuum-removed absorption features. *Remote Sensing of Environment* 89:393-408.
- National Academy of Science. 2000. Grand Challenges in Environmental Sciences. Oversight Commission for the Committee on Grand Challenges in Environmental Sciences, National Resource Council, National Academy Press, Washington, D.C.
- Nellis, M.D., and J.M. Briggs. 1997. Modelling impact of bison on tallgrass prairie. *Transactions Kansas Academy of Science* 100:3-9.
- Nippert, J.B., P.A. Fay, and A.K. Knapp. 2007. Photosynthetic traits in C₃ and C₄ grassland species in mesocosm and field environments. *Environmental and Experimental Botany* 60:412-420.

- Nippert, J.B., and A.K. Knapp. 2007a. Soil water partitioning contributes to species coexistence in tallgrass prairie. *Oikos* 116:1017-1029.
- Nippert, J.B., and A.K. Knapp. 2007b. Linking water uptake with rooting patterns in grassland species. *Oecologia* 153:261-272.
- Nippert, J.B., A.K. Knapp, and J.M. Briggs. 2006. Intra-annual rainfall variability and grassland productivity: can the past predict the future? *Plant Ecology* 184:65-74.
- Niyogi, D.K., K.S. Simon and C.R. Townsend. 2003. Breakdown of tussock grass in streams along a gradient of agricultural development in New Zealand. *Freshwater Biology* 48:1698-1708.
- Norman, G.W., and D.E. Steffen. 2003. Effects of recruitment, oak mast, and fall-season format on Wild Turkey harvest rates in Virginia. *Wildlife Society Bulletin* 31:553-559.
- Norris, M.A., J.M. Blair, and L.C. Johnson. 2007. Altered ecosystem nitrogen dynamics as a consequence of land cover change in tallgrass prairie. *American Midland Naturalist* 158:432-445.
- O'Brien J.M. 2006. Controls of nitrogen spiraling in Kansas streams. PhD dissertation, Kansas State University.
- O'Brien, J.M., and W.K. Dodds (*In Press*). Ammonium uptake and mineralization in prairie streams: chamber incubation and short-term nutrient addition experiments. *Freshwater Biology*.
- O'Brien, J. M. , W. K. Dodds, K. C. Wilson, J. N. Murdock and J. Eichmiller. 2007. The saturation of N cycling in Central Plains streams: 15N experiments across a broad gradient of nitrate concentrations. *Biogeochemistry* 84(8):31-49.
- Oedekoven, M A. and A. Joern. 2000. Plant quality and spider predation affects grasshoppers (Acrididae): food-quality -dependent compensatory mortality. *Ecology* 81:66-77.
- Osborne, C.P. 2008. Atmosphere, ecology and evolution: what drove the Miocene expansion of C₄ grasslands? *Journal of Ecology* online edition doi:10.1111/j.1365-2745.01323.11 p.
- Overpeck, J., C. Whitlock and B. Huntley. 2003. Terrestrial biosphere dynamics in the climate system: past and future. Pages 81-111. In K.D. Alverson, R.S. Bradley and T.F. Pederson (eds.) *Paleoclimate, Global Change and the Future*. Springer-Verlag, Berlin.
- Oviatt, C.G. 1998. Geomorphology of the Konza Prairie. Pages 35-47. In A.K. Knapp, J.M. Briggs, D.C. Hartnett and S.L. Collins (eds.) *Grassland Dynamics: Long-Term Ecological Research in Tallgrass Prairie*. Oxford University Press. New York.
- Palmer, M.A., R.F. Ambrose, and N.L. Poff. 1997. Ecological theory and community restoration ecology. *Restoration Ecology* 5:291-300.
- Palmer, M.A., D.A. Falk, and J.B. Zedler. 2005. Ecological theory and restoration ecology. Pages 1-10 in D.A. Falk, M.A. Palmer, and J.B. Zedler (editors), *Foundations of Restoration Ecology*. Island Press, Washington, DC.
- Panzer, R. 2003. Importance of in-situ survival, recolonization, and habitat gaps in the postfire recovery of fire-sensitive prairie insect species. *Natural Areas J.* 23: 14-21.
- Parr, C.L. and A.N. Anderson. 2006. Patch mosaic burning for biodiversity conservation: A critique of the pyrodiversity paradigm. *Conservation Biology* 20:1610-1619.
- Parmesan, C. and G. Yohe. 2003. A globally coherent fingerprint of climate change impacts across natural systems. *Nature* 421:37-42.
- Pastor, J. 2006. Delays in nutrient cycling and plant population oscillations. *Oikos*. 112: 698-705.

- Pennings, S.C., C.M. Clark, E.E. Cleland, S.L. Collins, L. Gough, K.L. Gross, D.G. Milchunas, and K.N. Suding. 2005. Do individual plant species show predictable responses to nitrogen addition across multiple experiments? *Oikos* 110:547-555.
- Perkins, S. 2007. Groundwater use adds CO₂ to the air. *Science News* 172:301.
- Peterson, B.J., W.M. Wollheim, P.J. Mulholland, J.R. Webster, J.L. Meyer, J.L. Tank, E. Marti, W.B. Bowden, H.M. Valett, A.E. Hershey, W.H. McDowell, W.K. Dodds, S.K. Hamilton, S. Gregory and D.D. Morrall. 2001. Control of nitrogen export from watersheds by headwater streams. *Science* 292:86-90.
- Phillips, R.L., O. Beeri, and M. Liebeg. 2006. Landscape estimation of C:N ratios under variable drought stress in Northern Great Plains rangelands. *Journal of Geophysical Research* 111:G02015, doi:02010.01029/02005JG000135.
- Polley, H.W., J.D. Derner, and B.J. Wilsey. 2005. Plant species diversity in remnant and restored tallgrass prairies: patterns and controls. *Restoration Ecology* 13:480-487.
- Porazinska, D.L., R.D. Bardgett, M.B. Blaauw, H.W. Hunt, A.N. Parsons, T.R. Seastedt, and D.H. Wall. 2003. Relationships at the aboveground-belowground interface: Plants, soil biota, and soil processes. *Ecological Monographs* 73:377-395.
- Porporato, A., G. Vico, and P.A. Fay. 2006. Superstatistics of hydro-climatic fluctuations and interannual ecosystem productivity. *Geophysical Research Letters* 33: doi:10.1029/2006GL026412.
- Powell, A.F.L. 2006. Effects of prescribed burns and bison (*Bos bison*) grazing on breeding bird abundances in tallgrass prairie. *Auk* 123:183-197.
- Price, K.P., F. Yu, R. Lee, and J. Ellis. 2004. Characterizing ecosystem variability of Northern China steppes using onset of green-up derived from time-series AVHRR NDVI data. *GIS & Remote Sensing Journal* 41:45-61.
- Ransom, M.D., C.W. Rice, T.C. Todd, and W.A. Wehmueller. 1998. Soils and soil biota. Pages 48-66. In A. K. Knapp, J. M. Briggs, D. C. Hartnett and S. L. Collins (eds.) *Grassland Dynamics: Long-Term Ecological Research in Tallgrass Prairie*. Oxford University Press. New York.
- Rastetter, E.B., and G.R. Shaver. 1992. A model of multiple element limitation for acclimating vegetation. *Ecology* 73:1157-1174.
- Reed, A.W., G.A. Kaufman, J.E. Boyer, Jr., and D.W. Kaufman. 2001. Seed use by vertebrates and invertebrates in tallgrass prairie. *Prairie Naturalist* 33:153-161.
- Reed, A.W., G.A. Kaufman, and D.W. Kaufman. 2004a. Influence of fire, topography, and consumer abundance on seed predation in tallgrass prairie. *Canadian Journal of Zoology* 82:1459-1467.
- Reed, A.W., G.A. Kaufman, and D.W. Kaufman. 2005. Rodent seed predation and GUDs: effect of burning and topography. *Canadian Journal of Zoology* 83:1279-1285.
- Reed, A.W., G.A. Kaufman, and D.W. Kaufman. 2006a. Species richness-productivity relationship for small mammals along a desert-grassland continuum: differential responses of functional groups. *Journal of Mammalogy* 87:777-783.
- Reed, A.W., G.A. Kaufman, and D.W. Kaufman. 2006b. Effect of plant litter on seed predation in three prairie types. *American Midland Naturalist* 155:278-285.
- Reed, A.W., G.A. Kaufman, D.A. Rintoul, and D.W. Kaufman. 2004b. Influence of prey abundance on raptors in tallgrass prairie. *Prairie Naturalist* 36:23-31.
- Reed, A.W., G.A. Kaufman, and B.K. Sandercock. 2007. Demographic response of a grassland rodent to environmental variability. *Journal of Mammalogy* 88:982-988.

- Reed, H., T.R. Seastedt, and J.M. Blair. 2005b. Ecological consequences of C₄ grass invasion of a C₄ grassland: A dilemma for management. *Ecological Applications* 15:1560-1569.
- Rehmeier, R.L., G.A. Kaufman, and D.W. Kaufman. 2006. An automatic activity-monitoring system for small mammals under natural conditions. *Journal of Mammalogy* 87:628-634.
- Rehmeier, R.L., G.A. Kaufman, D.W. Kaufman, and B.R. McMillan. 2005. Long-term study of abundance of the hispid cotton rat in native tallgrass prairie. *Journal of Mammalogy* 86:670-676.
- Reich, P.B., J. Knops, D. Tilman, , J. Craine, D. Ellsworth, M. Tjoelker, T. Lee, S. Naeem, D. Wedin, D. Bahauddin, G. Hendrey, S Jose. K. Wrage, J Goth, and W. Bengston. 2001b. Plant diversity enhances ecosystem responses to elevated CO₂ and nitrogen deposition. *Nature* 410:809-812.
- Reich, P.B., D.W. Peterson, D.A. Wedin, and K. Wrage. 2001a. Fire and vegetation effects on productivity and nutrient cycling across a forest-grassland continuum. *Ecology* 82:1703-1719.
- Reich, P.B., M.G. Tjoelker, M.B. Walters, D.W. Vanderklein, and C. Buschena. 1998. Close association of RGR, leaf and root morphology, seed mass and shade tolerance in seedlings of nine boreal tree species differing in relative growth rate. *Functional Ecology* 12:327-338.
- Rillig, M.C., and D.L. Mummey. 2006. Mycorrhizas and soil structure. *New Phytologist* 171: 41-53.
- Ripple, W.J., and R.L. Beschta. 2007. Hardwood tree decline following large carnivore loss on the Great Plains, USA. *Frontiers in Ecology and the Environment* 5:241-246.
- Risser, P.G., C.E. Birney, H.D. Blocker, S.W. May, W.J. Parton, and J.A. Wiens. 1981. The True Prairie Ecosystem. US/IBP Synthesis Series 16. Hutchinson Ross Publishing Company, Stroudsburg, Pennsylvania, USA.
- Roberts, B.J., P.J. Mulholland, W.R. Hill. 2007. Multiple scales of temporal variability in ecosystem metabolism rates: results from two years of continuous monitoring in a forested headwater stream. *Ecosystems* 10:588-606.
- Roesch L.F., R.R. Fulthorpe, A. Riva, G. Casella, A.K.M. Hadwin, A.D. Kent, S.H. Daroub, F.A.O. Camargo, W.G. Farmerie, and E.W. Triplett. 2007. Pyrosequencing enumerates and contrasts soil microbial diversity. *ISME Journal* 1:283-290.
- Rogers, W.E., and D.C. Hartnett. 2001. Temporal vegetation dynamics and recolonization mechanisms on different-sized soil disturbances in tallgrass prairie. *American Journal of Botany* 88:1634-1642.
- Ross, B.E., A.W. Reed, R.L. Rehmeier, G.A. Kaufman, and D.W. Kaufman. 2007. Effects of prairie vole runways on tallgrass prairie. *Kansas Academy of Science, Transactions* 110:100-106.
- Sala, O.E. 2001. Temperate Grasslands. Pages 121-137 in Chapin, F.S. III, O.E. Sala and E. Huber-Sannwald (eds.), *Global Biodiversity in a Changing Environment. Scenarios for the 21st Century. Ecological Studies* 152. Springer, New York, NY.
- Sala, O.E., W.J. Parton, L.A. Joyce, and W.K. Lauenroth. 1988. Primary production of the central grassland region of the United States. *Ecology* 69:40-45.
- Samson, F., and F. Knopf. 1994. Prairie conservation in North America. *BioScience* 44:418-421.
- Sandercock, B.K. 2006. Estimation of demographic parameters from live encounter data: a summary review. *Journal of Wildlife Management* 70:1504-1520.
- Sandercock, B. K., and A. Jaramillo. 2002. Annual survival rates of wintering sparrows: assessing demographic consequences of migration. *Auk* 119:149-165.
- Sandercock, B.K., W.E. Jensen, C.K. Williams, and R.D. Applegate (*In Press*). Demographic sensitivity of population change in the Northern Bobwhite: a life-stage simulation analysis. *Journal of Wildlife Management*.

- Schaefer, J., K. Gido, and M. Smith. 2005. A test for community change using a null model approach. *Ecological Applications* 15:1761-1771.
- Schlesinger, W.H. 1997. *Biogeochemistry - An Analysis of Global Change*. Academic Press, San Diego, CA.
- Schmidt, K.A., and R.S. Ostfeld. 2003. Songbird populations in fluctuating environments: predator responses to pulsed resources. *Ecology* 84:406-415.
- Schnurr, J.L., R.S. Ostfeld, and C.D. Canham. 2002. Direct and indirect effects of masting on rodent populations and tree seed survival. *Oikos* 96:402-410.
- Schumaker N.H., T. Ernst, D. White, J. Baker, and P. Haggerty. 2004. Projecting wildlife responses to alternative future landscapes in Oregon's Willamette Valley. *Ecological Applications* 14: 381-401.
- Seastedt, T.R., and A.K. Knapp. 1993. Consequences of non-equilibrium resource availability across multiple time scales: the transient maxima hypothesis. *American Naturalist* 141: 621-633.
- Seastedt, T.R., T.C. Todd, and S.W. James. 1987. Experimental manipulations of arthropod, nematode and earthworm communities in a North American tallgrass prairie. *Pedobiologia*. 30:9-17.
- Senft, R.L., M.B. Coughenour, D.W. Bailey, L.R. Rittenhouse, O.E. Sala, and D.M. Swift. 1987. Large herbivore foraging and ecological hierarchies. *BioScience* 37:789-795.
- Shaw, M.R., E.S. Zavaleta, N.R. Chiariello, E.E. Cleland, H.A. Mooney, C.B. Field. 2002. Grassland responses to global environmental changes suppressed by elevated CO₂, *Science* 298:1987-1990.
- Sherry, A., X. Zhou, S. Gu, J. A. Amone III, D. S. Schimel, P. S. Verburg, L. L. Wallace, and Y. Luo. 2007. Divergence of reproductive phenology under climate warming. *PNAS* 104:198-202.
- Silletti, A.M., and A.K. Knapp. 2001. Responses of the co-dominant grassland species *Andropogon gerardii* and *Sorghastrum nutans* to long-term manipulations of nitrogen and water. *American Midland Naturalist* 145:159-167.
- Silletti, A.M., and A.K. Knapp. 2002. Long-term responses of the grassland co-dominants *Andropogon gerardii* and *Sorghastrum nutans* to changes in climate and management. *Plant Ecology* 163:15-22.
- Simon, K.S., C.R. Townsend, B.J.F. Biggs, W.B. Bowden, and R.D. Frew. 2004. Habitat-specific nitrogen dynamics in New Zealand streams containing native or invasive fish. *Ecosystems* 7:777-792.
- Simonson R.W. 1995. Airborne dust and its significance to soils. *Geoderma* 65:1-43.
- Slavik, K., B.J. Peterson, L.A. Deegan, W.B. Bowden, A.E. Hershey, and J.E. Hobbie. 2004. Long-term responses of the Kuparuk River ecosystem to phosphorus fertilization. *Ecology* 85:939-954.
- Smith, D.L., and L.C. Johnson. 2003. Expansion of *Juniperus* in the Great Plains: Changes in soil organic carbon dynamics. *Global Biogeochemical Cycles* 17: doi:10.1029/2002GB001990
- Smith, D.L., and L.C. Johnson. 2004. Vegetation-mediated changes in microclimate reduce soil respiration as woodlands expand into grasslands. *Ecology* 85:3348-3361
- Smith, M.D., D.C. Hartnett, and G.W.T. Wilson. 1999. Interacting influence of mycorrhizal symbiosis and competition on plant diversity in tallgrass prairie. *Oecologia* 121:574-582.
- Smith, M.D., and A.K. Knapp. 1999. Exotic plant species in a C₄-dominated grassland: Invasibility, disturbance and community structure. *Oecologia* 120: 605-612.
- Smith, M.D., and A.K. Knapp. 2003. Dominant species maintain ecosystem function with non-random species loss. *Ecology Letters* 6:509-517
- Smith, M.D., A.K. Knapp, and S.L. Collins. Global change and resource alterations: moving beyond disturbance as a primary driver of contemporary ecological dynamics. *Oecologia*, submitted.

- Smith, M.D., J. Wilcox, T. Kelly, and A.K. Knapp. 2004. Dominance not diversity determines invasibility of tallgrass prairie. *Oikos* 106:253-262.
- Smith R.M., P.C. Twiss, R.K. Krauss, and M.J. Brown. 1970. Dust deposition in relation to site, season, and climatic variables. *Proceedings of the Soil Science Society of America* 34:112-117.
- Sork, V.L., J. Bramble, and O. Sexton. 1993. Ecology of mast-fruiting in three species of North American deciduous oaks. *Ecology* 74:528-541.
- Stagliano, D.M., and M.R. Whiles. 2002. Macroinvertebrate production and trophic structure in a tallgrass prairie headwater stream. *Journal of the North American Benthological Society* 21:97-113.
- Stapanian, M.A., and C.C. Smith. 1986. How fox squirrels influence invasion of prairies by nut-bearing trees. *Journal of Mammalogy* 67:326-332.
- Stapanian, M.A., C.C. Smith, and E.J. Finck. 1999. Weather effects on winter birds: the response of a Kansas winter bird community to weather, photoperiod, and year. *Wilson Bulletin* 111:550-558.
- Status of Pollinators in North America. 2007. Committee on the Status of Pollinators in North America, National Research Council. National Academies Press, Washington, D.C. 326 pp.
- St. John, M.G., D.H. Wall, and V.M. Behan-Pelletier. 2006b. Does plant species co-occurrence influence soil mite diversity? *Ecology* 87:625-633.
- St. John, M.G., D.H. Wall, and H.W. Hunt. 2006a. Are soil mite assemblages structured by the identity of native and invasive alien grasses?. *Ecology* 87:1314-1324.
- Stieglitz, M., D. Rind, J. Famiglietti, and C. Rosenzweig. 1997. An efficient approach to modeling the topographic control of surface hydrology for regional and global climate modeling. *Journal of Climate* 10: 118-137.
- Stieglitz, M., J. Shaman, J. McNamara, G.W. Kling, V. Engel, J. Shanley. 2004. An approach to understanding hydrologic connectivity on the hillslope and the implications for nutrient transport. *Global Biogeochemical Cycles*, Vol. 17, doi:10.1029/2003GB002041
- Suding, K.N., S.L. Collins, L. Gough, C. Clark, E.E. Cleland, K.L. Gross, D.G. Milchunas, and S. Pennings. 2005. Functional and abundance based mechanisms explain diversity loss due to nitrogen fertilization. *Proceedings of the National Academy of Sciences* 102:4387-4392.
- Suttle, K.B., M.A. Thomsen, and M.E. Power. 2007. Species interactions reverse grassland responses to changing climate. *Science* 315:640-642.
- Swap, R., M. Garstang, S. Greco, R. Talbot, and P. Kallberg. 1992. Saharan dust in the Amazon Basin. *Tellus Series B* 44:133-149.
- Swemmer, A.M., A.K. Knapp, and M.D. Smith. 2006. Growth responses of two dominant C₄ grass species to altered water availability. *International Journal of Plant Sciences* 167:1001-1010.
- Swemmer, A.M., A.K. Knapp and H.A. Snyman. 2007. Intra-seasonal precipitation patterns and aboveground productivity in three perennial grasslands. *Journal of Ecology* 95:780-788..
- Tank, J.L., and W.K. Dodds. 2003. Responses of heterotrophic and autotrophic biofilms to nutrients in ten streams. *Freshwater Biology* 48:1031-1049.
- Taylor, B.W., A.S. Flecker, and R.O. Hall. 2006. Loss of a harvested fish species disrupts carbon flow in a diverse tropical river. *Science* 313:833-836.
- Tilman, D., and D. Wedin. 1991. Oscillations and chaos in the dynamics of a perennial grass. *Nature*. 353: 653-655.
- Todd, T.C. 1996. Effects of management practices on nematode community structure in tallgrass prairie. *Applied Soil Ecology* 3:235-246.

- Towne, E. G. 2002. Vascular plants of Konza Prairie Biological Station: an annotated checklist of species in a Kansas tallgrass prairie. *Sida* 20: 269-294.
- Towne, E.G., D.C. Hartnett, and R.C. Cochran. 2005. Vegetation trends in tallgrass prairie from bison and cattle grazing. *Ecological Applications* 15:1550-1559.
- Towne, E.G., and K.E. Kemp. 2003. Vegetation dynamics from annually burning tallgrass prairie in different seasons. *Journal of Range Management* 56:185-192.
- Trager, M., G.W.T. Wilson, and D.C. Hartnett. 2004. Interactive effects of burn regime and bison activity on tallgrass prairie vegetation. *American Midland Naturalist* 152:237-247.
- Travers, S.E., M.D. Smith, J. Bai, S.H. Hulbert, J.E. Leach, P.S. Schnable, A.K. Knapp, G.A. Milliken, P.A. Fay, A. Saleh and K.A. Garrett. 2007. Ecological genomics: making the leap from model systems in the lab to native populations in the field. *Frontiers in Ecology and the Environment*. *Frontiers in Ecology and the Environment* 5:19-24.
- Turner, C.T., J.M. Blair, R.J. Scharz, and J.C. Neel. 1997. Soil N and plant responses to fire, topography and supplemental N in tallgrass prairie. *Ecology* 78:1832-1843.
- Turner, C.T., and A.K. Knapp. 1996. Responses of a C₄ grass and three C₃ forbs to variation in nitrogen and light in tallgrass prairie. *Ecology* 77:1738-1749.
- Turner, C.T., J.R. Kneisler, and A.K. Knapp. 1995. Comparative gas exchange and nitrogen responses of the dominant C₄ grass, *Andropogon gerardii*, and five C₃ forbs to fire and topographic position in tallgrass prairie during a wet year. *International Journal of Plant Science* 156:216-226.
- Turner, D.P., W.D. Ritts, W.B. Cohen, S.T. Gower, SW. Running, M. Zhao, M.H. Costa, A. Kirschbaum, J. Ham, S. Saleska, and D.E. Ahl. 2006. Evaluation of MODIS NPP and GPP products across multiple biomes. *Remote Sensing of Environment* 102: 282-292.
- Turner, D.P., D. Urbanski, D. Bremer, S.C. Wofsy, T. Meyers, S.T. Gower, and M. Gregory. 2003a. A cross-biome comparison of daily light use efficiency for gross primary production. *Global Change Biology* 9:383-395.
- Turner, M.G., S.L. Collins, A.L. Lugo, J.J. Magnuson, T.S. Rupp, and F.J. Swanson. 2003b. Disturbance dynamics and ecological response: the contribution of long-term ecological research. *BioScience* 53:46-56
- van der Hoek, D.-J., A.K. Knapp, J.M. Briggs, and J. Bokdam. 2002. White-tailed deer browsing on six shrub species of tallgrass prairie. *Great Plains Research* 12:141-156.
- van Wilgen, B.W., W.S.W. Trollope, H.C. Biggs, A.L.F. Potgieter, and B. Brockett. 2003. Fire as a driver of ecosystem variability. Pp. 149-170 In: J.T. Du Toit, K.H. Rogers, and H.C. Biggs (eds.) *The Kruger Experience: Ecology and Management of Savanna Heterogeneity*. Island Press, Washington, D.C.
- Vanni, M.J., A.S. Flecker, J.M. Hood, and J.L. Headworth. 2002. Stoichiometry of nutrient recycling by vertebrates in a tropical stream: linking species identity and ecosystem processes. *Ecology Letters* 5:285-293.
- Veen, G.F., J.M. Blair, M.D. Smith, and S.L. Collins. Influence of grazing and fire frequency on small-scale plant community structure and resource variability in native tallgrass prairie. *Oikos (in press)*
- Villarreal, M., R.C. Cochran, D.E. Johnson, E.G. Towne, G.W.T. Wilson, D.C. Hartnett, and D.G. Goodin. 2006. The use of pasture reflectance characteristics and arbuscular mycorrhizal root colonization to predict pasture characteristics of tallgrass prairie grazed by cattle and bison. *Grass and Forage Science* 61:32-41.

- Vinton, M.A., D.C. Hartnett, E.J. Finck, and J.M. Briggs. 1993. The interactive effects of fire, bison (*Bison bison*) grazing and plant community composition in tallgrass prairie. *American Midland Naturalist* 129:10-18.
- Vitousek, P.M., H.A. Mooney, J. Lubchenco, and J.M. Melillo. 1997. Human domination of the Earth's ecosystems. *Science* 277:494-499.
- Vogl, R.J. 1974. Effects of fire on grasslands. in T.T. Kozlowski, and C.E. Ahlgren, (eds.) *Fire and Ecosystems*, Academic Press, New York, New York, USA.
- Walker, B. 2001. Tropical savannas. Pages 139-156 in F.S. Chapin, O.E. Sala, and E. Huber-Sannwald (eds.), *Global Biodiversity in a Changing Environment*. Ecological Studies Vol. 152, Springer, NY.
- Walker, J.S., and J.M. Briggs. 2007. An object-oriented approach to urban forest mapping with high-resolution, true-color aerial photography. *Photogrammetric Engineering & Remote Sensing* 73:577-583.
- WallisDeVries, M.F., J.P. Bakker, and S.E. Van Wieren (eds.). 1998. *Grazing and Conservation Management*. Kluwer Academic Publishers, Dordrecht, The Netherlands.
- Walther, G.-R., E. Post, A. Menzel, C. Parmesan, T.J.C. Beebee, J.-M. Fromentin, O. Hoegh-Guldberg, and F. Bairlein. 2002. Ecological responses to recent climate change. *Nature* 416:389-39.
- Webster, J.R., P.J. Mulholland, J.L. Tank, H.M. Valett, W.K. Dodds, B.J. Peterson, W.B. Bowden, C.N. Dahm, S. Findlay, S.V. Gregory, N.B. Grimm, S.K. Hamilton, S.L. Johnson, E. Marti, W.H. McDowell, J.L. Meyer, D.D. Morrall, S.A. Thomas, and W.M. Wollheim. 2003. Factors affecting ammonium uptake in streams - an inter-biome perspective. *Freshwater Biology* 48:1329-1352.
- Weiherr, E., and P. Keddy. 1995. The assembly of experimental wetland communities. *Oikos* 73:323-335.
- Weiherr, E., and P. Keddy. 1999. *Ecological Assembly Rules: Perspectives, Advances, Retreats*. Cambridge University Press, Cambridge, MA.
- Weltzin, J.F., M.E. Loik, S. Schwinning, D.G. Williams, P. Fay, B. Haddad, J. Harte, T. E. Huxman, A.K. Knapp, G. Lin, W.T. Pockman, M.R. Shaw, E. Small, M.D. Smith, D. T. Tissue, and J.C. Zak. 2003. Assessing the response of terrestrial ecosystems to potential changes in precipitation. *BioScience* 53:941-952.
- Westoby, M., and I.J. Wright. 2006. Land-plant ecology on the basis of functional traits. *Trends in Ecology and Evolution* 21: 261-268.
- Whelan, R.J. 1995. *The Ecology of Fire*. Cambridge University Press, Cambridge UK
- Whiles, M.R. and R.E. Charlton. 2006. The ecological significance of tallgrass prairie arthropods. *Annual Review of Entomology* 51:387-412.
- Whiles, M. R., and W.K. Dodds. 2002. Relationships between stream size, suspended particles, and filter-feeding macroinvertebrates in a Great Plains drainage network. *Journal of Environmental Quality* 31:1589-1600.
- Whiles, M.R., K.R. Lips, C.M. Pringle, S.S. Kilham, R. Brenes, S. Connelly, J.C. Colon Gaud, M. Hunte-Brown, A.D. Huryn, C. Montgomery, and S. Peterson. 2006. The consequences of amphibian population declines to the structure and function of Neotropical stream ecosystems. *Frontiers in Ecology and the Environment* 4:27-34.
- White, D.C., and D.B. Ringelberg. 1998. Signature lipid biomarker analysis. Pages 255-272 in R.S. Burlage, R. Atlas, D. Stahl, G. Geesey and G. Saylor (eds.) *Techniques in Microbial Ecology*, Oxford University Press, New York.

- White, E.P., P.B. Adler, W.K. Lauenroth, R.A. Gill, D. Greenberg, D.M. Kaufman, A. Rassweiler, R.A. Rusak, M.D. Smith, J. Steinbeck, R.B. Waide, and J. Yao. 2006. A cross-site, cross-taxonomic comparison of species-time relationship. *Oikos* 112: 185-195.
- Whitfield, J.B., and C.N. Lewis. 2001. Analytical survey of the braconid wasp fauna (Hymenoptera: Braconidae) on six midwestern U.S. tallgrass prairies. *Annals of the Entomological Society of America* 94: 230-238.
- Wiggam, S. W. and C. J. Ferguson. 2005. Pollinator importance and temporal variation in a population of *Phlox divaricata* L. (Polemoniaceae). *American Midland Naturalist* 154: 42-54.
- Wilgers, D.J., and E.A. Horne. 2006. Effects of different burn regimes on tallgrass prairie herpetofaunal species diversity and community composition in the Flint Hills, Kansas. *Journal of Herpetology* 40:73-84.
- Wilgers, D.J., E.A. Horne, B.K. Sandercock, and A.W. Volkmann. 2006. Effects of rangeland management on community dynamics of the herpetofauna of the tallgrass prairie. *Herpetologica* 62:378-388.
- Williams, J.W., S.T. Jackson, and J.E. Kutzbach. 2007. Projected distributions of novel and disappearing climates by 2100 A.D. *Proceedings of the National Academy of Sciences* 104:5738-742.
- Wilson, G.W.T., D.C. Hartnett, and C. W. Rice. 2006. Mycorrhizal-mediated phosphorus transfer between tallgrass prairie plants *Sorghastrum nutans* and *Artemisia ludoviciana*. *Functional Ecology* 20:427-435.
- Wilson, K.C. 2005. Hyporheic oxygen flux and substratum spatial heterogeneity: effects on whole-stream dynamics. MS Thesis, Kansas State University.
- Wood, H.K. and G.L. Macpherson. 2005. Sources of Sr and implications for weathering of limestone under tallgrass prairie, northeastern Kansas. *Applied Geochemistry* 20:2325-2342.
- Woods, T.M. 2006. A comparison of the reproductive systems of the invasive *Lespedeza cuneata* (Dum.-Cours.) G. Don (Fabaceae) with three native congeners in the Flint Hills region of the tallgrass prairie. MS Thesis, Kansas State University. Manhattan, KS. 95 pp
- Woods, T. M., S. C. Strakosh, M. P. Nepal, S. Chakrabarti, N. B. Simpson, M. H. Mayfield and C. J. Ferguson. 2005. Introduced species in Kansas: floristic changes and patterns of collection based on an historical herbarium. *Sida* 21: 1695-1725.
- Yeates, G. W., T. Bongers, R.G. M. de Goede, D.W. Freckman, and S.S. Georgeva. 1993. Feeding habits in soil nematode families and genera - An outline for soil ecologists. *Journal of Nematology* 25: 315-331.
- Zeglin, L.H., M. Stursova, R.L. Sinsabaugh, and S.L. Collins. 2007. Microbial responses to nitrogen addition in three contrasting grassland ecosystems. *Oecologia* 154:349-359.
- Zobel, M. 1997. The relative role of species pools in determining plant species richness; an alternative explanation of species coexistence. *Trends in Ecology and Evolution* 12:266-269.
- Zollner, P.A. and S.L. Lima. 1999. Search strategies for landscape-level interpatch movements. *Ecology* 80:1019-1030.